

HYDRONIC & DOMESTIC HOT WATER SYSTEMS ANCILLARY EQUIPMENT & ACCESSORIES

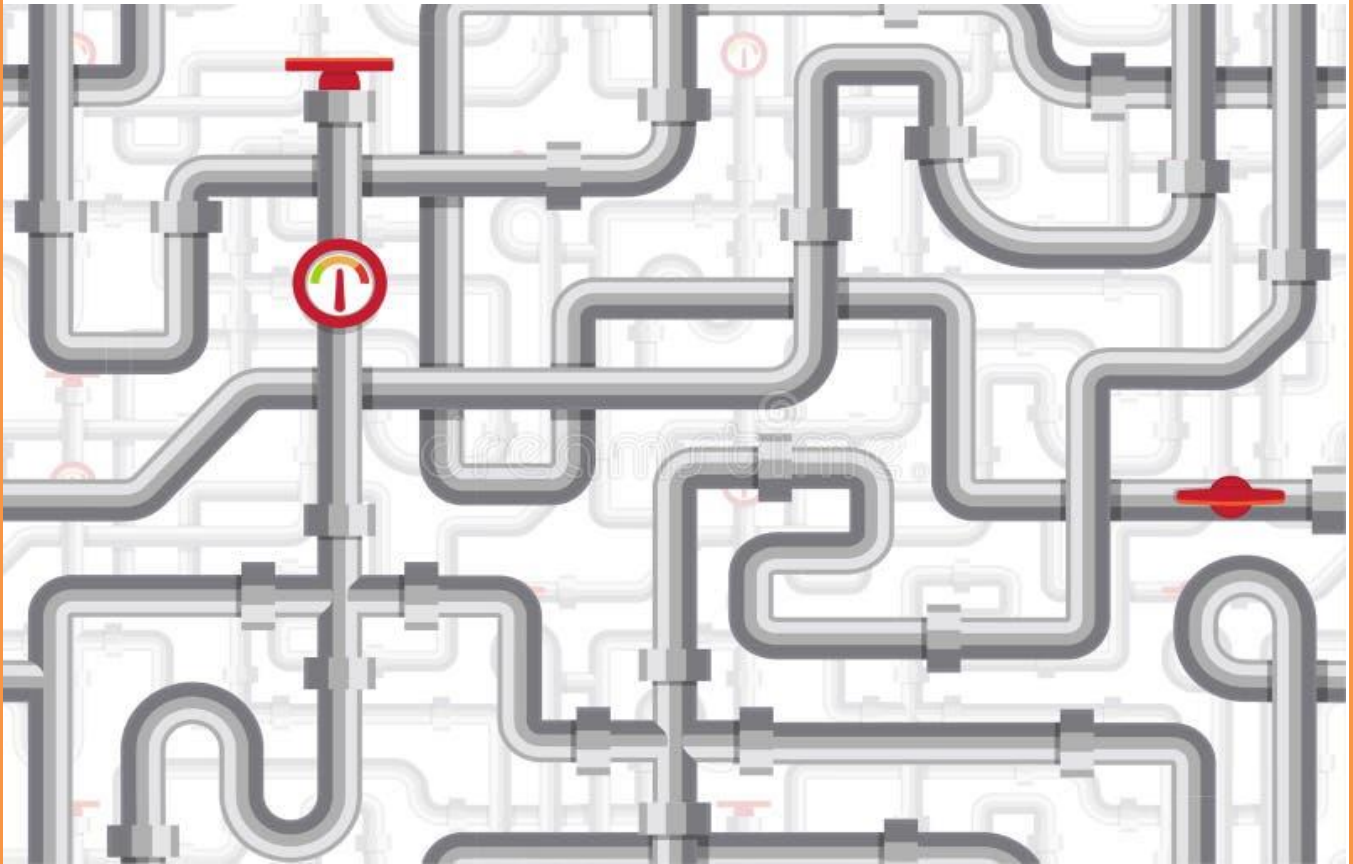

HYDRONIC & DOMESTIC HOT WATER SYSTEMS ANCILLARY & ACCESSORY EQUIPMENT

INDEX

<u>AIR, DIRT, HYDRAULIC SEPARATORS</u>	<u>PAGE</u>
- Grundfos Air Separator - Tangential GAS and GASL Models (2" to 24")	
> GASL Model (Less Strainer)	1
> GAS Model (With Strainer)	2
- Grundfos Air Separator - Coalescing Models (2" to 24")	
> GASF Model (Standard Velocity / Fixed Head)	3
> GAHF Model (High Velocity / Fixed Head)	4
- Grundfos Air/Dirt Separator - Coalescing Models (2" to 24")	
> GBSF Model (Standard Velocity / Fixed Head)	5
> GBHF Model (High Velocity / Fixed Head)	6
> GBSR Model (Standard Velocity / Removable Head)	7
> GBHR Model (High Velocity / Removable Head)	8
- Grundfos Hydraulic/Air/Dirt Separator - Coalescing Models (2" to 12")	
> G4SF Model (Standard Velocity / Fixed Head)	9
> G4SR Model (Standard Velocity / Removable Head)	10
- Spirovent Quad Hydraulic/Air/Dirt Separator - Coalescing Models (2" to 12")	
> VDX MT Models (Fixed Head / Threaded)	11
> VDX FA Models (Fixed Head / Flanged)	11
> VDX FAM Models (Fixed Head / Magnet / Flanged)	11
> VDN FA Models (Removable Head / Flanged)	12
- Hydraulic/Air/Dirt Separator - Supply Manifold Sizing on Multiple Units	13
<u>BUFFER TANKS</u>	
- <u>CHILLED WATER</u>	
- Grundfos Chilled Water Buffer Tanks - GCWBT Models (120 to 3000 Gallons)	14
- Thermal Solutions Chilled Buffer Tanks - TSCB Models (130 to 2000 Gallons)	15

HYDRONIC & DOMESTIC HOT WATER SYSTEMS ANCILLARY & ACCESSORY EQUIPMENT

INDEX

<u>BUFFER TANKS (Continued)</u>	<u>PAGE</u>
- <u>HOT WATER</u>	
- Grundfos Hot Water Buffer Tanks - GHWBT Models (120 to 300 Gallons)	
> GHWBT Models (2-Ports)	16
> GHWBT Models (4-Ports)	16
- Thermal Solutions Hot Water Buffer Tanks - TSHB Models (40 to 1000 Gallons)	17
- H2OMax Hot Water Buffer Tanks - B Models (26 to 119 Gallons)	18
<u>CHEMICAL FEED SYSTEMS</u>	
- A&F Machine Chemical Feed Systems	19
- A&F Machine Chemical Shot and Shot Bypass Feeders	20 - 21
<u>EXPANSION TANKS</u>	
- <u>HYDRONIC EXPANSION</u>	
- Grundfos Expansion Tanks - Fixed Diaphragm / Partial Acceptance	
> GAX Models - Vertical (8.6 to 211 Gallons)	22
> GAX Models - Inline-Horizontal (6.4 to 211 Gallons)	23
- Grundfos Expansion Tanks - Replaceable Bladder / Partial Acceptance	
> GLBC Models - Standard Pressure, 125 & 150 PSI (10 to 44 Gallons)	24
> GLBC Models - Higher Pressures, 250 PSI (10 to 44 Gallons)	24
- Grundfos Expansion Tanks - Replaceable Bladder / Full Acceptance	
> GL Models - Standard Pressure, 125 & 150 PSI (53 to 3963 Gallons)	25
> GL Models - Higher Pressures, 250 PSI (53 to 3963 Gallons)	26
- Thermal Solutions Expansion Tanks - Replaceable Bladder / Full Acceptance	
> TSET Models - Standard Pressure, 125 PSI (40 to 1000 Gallons)	27

HYDRONIC & DOMESTIC HOT WATER SYSTEMS ANCILLARY & ACCESSORY EQUIPMENT

INDEX

<u>EXPANSION TANKS</u>	<u>PAGE</u>
- <u>THERMAL EXPANSION - DHW, NSF-61, FDA-APPROVED</u>	
- Grundfos Expansion Tanks - Fixed Diaphragm / Partial Acceptance > GST-DD & VC Models - Standard Pressure, 150 PSI (2.0 to 90 Gallons)	28
- <u>THERMAL EXPANSION - DHW, NSF-61, FDA-APPROVED</u>	
- Grundfos Expansion Tanks - Bladder Type / Partial Acceptance > GST-CL Models - Standard Pressure, 150 PSI (10 to 158 Gallons)	29
- Grundfos Expansion Tanks - Bladder Type / Full Acceptance > GST-C Models - Standard Pressure, 150 PSI (53 to 528 Gallons)	30
- <u>THERMAL EXPANSION - DHW, NSF-61</u>	
- Thermal Solutions Expansion Tanks - Bladder Type / Full Acceptance > TSET Models - Standard Pressure, 150 PSI (40 to 1000 Gallons)	31
- <u>HYDRO-PNEUMATIC EXPANSION - WELL / BOOSTER PUMP, NSF-61, FDA-APPD</u>	
- Grundfos Expansion Tanks - Fixed Diaphragm / Partial Acceptance > GWX-CDD & C Models - Std Pressure, 175 PSI (2 to 132 Gallons)	32
- Grundfos Expansion Tanks - Bladder Type / Partial Acceptance > GWX-CL Models - Standard Pressure, 125 PSI (10 to 158 Gallons)	33
- Grundfos Expansion Tanks - Bladder Type / Full Acceptance > GWX-C Models - Standard Pressure, 125 PSI (53 to 1980 Gallons)	34

HYDRONIC & DOMESTIC HOT WATER SYSTEMS ANCILLARY & ACCESSORY EQUIPMENT

INDEX

<u>GAS DETECTION MONITOR</u>	<u>PAGE</u>
- AGS Mini Merlin Gas Detection Monitor (Carbon Monoxide/Methane)	35
<u>GLYCOL FEED SYSTEMS</u>	
- Grundfos GGMP Models - Single System Package (6 to 100 Gallons)	36
- Grundfos GGMPD Models - Twin Systems / One Package (50 or 100 Gallons)	36
- Grundfos GGMPPT Models - Single System w/ Duplex Pump Package (50 or 100 Gallons)	37
- A&F Machine AF Models - Single System/Customization (50 or 100 Gallons)	37
<u>HEAT EXCHANGERS</u>	
- Plate & Frame, Shell & Tube, Brazed Plate - Info Needed for Sizing & Quoting	38
<u>MAGNETIC FILTERS</u>	
- BoilerMag BMXT Commercial Magnetic Filters (1.5" NPT to 12" Flanged)	39
<u>PUMPS</u>	
- See Pump Kits in Products Pricing Sheets and Performance Curves	----
<u>PUMP ACCESSORIES</u>	
- Grundfos SD Model Suction Diffusers (2" x 1.5" to 12" x 12")	
> Grundfos SD Model Suction Diffusers - 125 PSIG ANSI	40
> Grundfos SD Model Suction Diffusers - 250 PSIG ANSI	41
- Grundfos CV Model Combination Valves (2" to 14")	
> Grundfos CV Model Combination Valves - 125 PSIG ANSI	42
> Grundfos CV Model Combination Valves - 250 PSIG ANSI	42

HYDRONIC & DOMESTIC HOT WATER SYSTEMS ANCILLARY & ACCESSORY EQUIPMENT

INDEX

<u>STORAGE TANKS</u>	<u>PAGE</u>
- Thermal Solutions Hot Water Storage Tanks - Vertical (40 - 1,820 Gallons)	
> Small Volume Tanks - TSV Models (40 to 200 Gallons)	43
> Large Volume Tanks - TSV Models (175 to 1820 Gallons)	44
- Bare and Jacket & Insulation	
> Large Volume Tanks - TSV Models (175 to 1040 Gallons)	45
- Stainless Steel	
> Large Volume Tanks - TSV Models (175 to 1820 Gallons)	46
- Interior (Linings), Exterior & Tank Design (PSI) Options	
- Thermal Solutions Hot Water Storage Tanks - Horizontal (175 - 1,820 Gallons)	
> Large Volume Tanks - TSH Models (175 to 1820 Gallons)	47
- Bare and Jacket & Insulation	
> Large Volume Tanks - TSH Models (175 to 1040 Gallons)	48
- Stainless Steel	
> Large Volume Tanks - TSH Models (175 to 1820 Gallons)	49
- Interior (Linings), Exterior & Tank Design (PSI) Options	
- Thermal Solutions Hot Water Storage Tanks - Vertical & Horizontal Models	
> Large Volume Tanks - TSV & TSH Models - Tank Illustrations	50
<u>THERMOSTATIC MIXING VALVES</u>	
- FPE Thermostatic Mixing Valves - 2" to 6"	51
<u>WATER HEATERS</u>	
- Thermal Solutions Indirect Water Heaters	
> Hot Water Generators -TSG Models - Vertical / Horizontal (175+ Gallons)	
- Package Components & Options	52
- Information Needed to Size & Quote	53
> Power Plate Water Heating Systems -TSPH Models (Up to 2500 Glns)	54
> H2OMax Heat Exchangers - H Models (26 to 119 Gallons)	55

HYDRONIC & DOMESTIC HOT WATER SYSTEMS ANCILLARY & ACCESSORY EQUIPMENT

INDEX

WATER HEATERS (Continued)

PAGE

- Thermal Solutions Direct Water Heaters	
> Electric-Powered -TSEV (175 to 2500 Gallons)	
- Package Components & Options	56
- Electrical 208V, 240V, 277V Pricing - 15 thru 216 KW	57
- Electrical 208V, 240V, 277V Pricing - 234 thru 360 KW	58
- Electrical 380V, 400V, 415V, 480V, 600V Pricing - 15 thru 72 KW	58
- Electrical 380V, 400V, 415V, 480V, 600V Pricing - 90 thru 360 KW	59
- Options	60

AIR, DIRT, HYDRAULIC SEPARATORS

AIR SEPARATORS

GRUNDFOS AIR SEPARATORS - TANGENTIAL, GASL MODELS (125 PSI)

Less Strainer

Model Sizes	Pipe Size (Inches)	Connection	Height (Inches)	Width (Inches)	Velocity * 6 ft./sec. (GPM)	Anchor Clips		Shipping Weight (lbs)
						Part Number	Part Number	
GASL 2	2	Flanged	23	17	63	TBD	TBD	41
GASL 2.5	2.5	Flanged	23	17	90	TBD	TBD	50
GASL 3	3	Flanged	23	17	140	TBD	TBD	56
GASL4	4	Flanged	25	21	240	TBD	TBD	66
GASL 5	5	Flanged	39	24	375	TBD	TBD	175
GASL 6	6	Flanged	45 1/2	26	540	TBD	TBD	190
GASL 8	8	Flanged	56 1/2	32	940	TBD	TBD	350
GASL 10	10	Flanged	62 1/2	40	1,500	TBD	TBD	700
GASL 12	12	Flanged	80 1/2	46	2,100	TBD	TBD	912
GASL 14	14	Flanged	100 1/2	56	2,500	TBD	TBD	1,853
GASL 16	16	Flanged	102 1/2	64	2,800	TBD	TBD	2,610
GASL 18	18	Flanged	114 1/2	64	4,200	TBD	TBD	2,900
GASL 20	20	Flanged	107	70	5,600	TBD	TBD	4,560
GASL 22	22	Flanged	126	70	6,300	TBD	TBD	5,320
GASL 24	24	Flanged	139	82	7,000	TBD	TBD	6,175

* Velocity rates are available as high as 10 ft./sec., but 6 ft./sec. is the optimum for air elimination.

Air Vent Valve

Model Sizes	Air Vent Valve (Inches)	Height (Inches)	Width (Inches)	Part Number	Shipping Weight (lbs)
747 Air Vent	3/4	9 1/2	4 1/4	TBD	8

No Anchor Clips

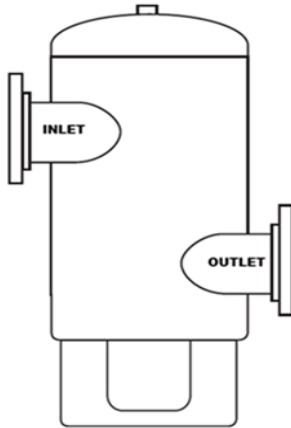

With Anchor Clips

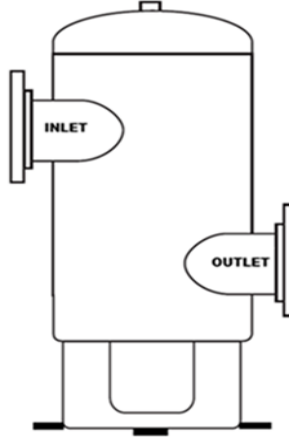

- Notes: 1) Shell & Heads: Carbon Steel; Max Temp: 350° F.
 2) Exterior: Primer & Black Paint Finish.
 3) Maximum Working Pressure: 125 PISG.

AIR, DIRT, HYDRAULIC SEPARATORS

AIR SEPARATORS

GRUNDFOS AIR SEPARATORS - TANGENTIAL, GAS MODELS (125 PSI)

With Strainer

Model Sizes	Pipe Size (Inches)	Connection	Height (Inches)	Width (Inches)	Max Flow (GPM)	No Anchor Clips		With Anchor Clips		Shipping Weight (lbs)
						Part Number		Part Number		
GAS 2	2	NPT	23	17	56	TBD		TBD		45
GAS 2.5	2.5	NPT	23	17	90	TBD		TBD		54
GAS 3	3	Flanged	23	17	190	TBD		TBD		60
GAS 4	4	Flanged	25	21	300	TBD		TBD		70
GAS 5	5	Flanged	39	24	530	TBD		TBD		200
GAS 6	6	Flanged	45 1/2	26	850	TBD		TBD		249
GAS 8	8	Flanged	56 1/2	32	1,900	TBD		TBD		375
GAS 10	10	Flanged	62 1/2	40	3,200	TBD		TBD		750
GAS 12	12	Flanged	80 1/2	46	4,800	TBD		TBD		950
GAS 14	14	Flanged	100 1/2	56	6,100	TBD		TBD		2,200
GAS 16	16	Flanged	102 1/2	64	8,000	TBD		TBD		3,000
GAS 18	18	Flanged	114 1/2	64	9,700	TBD		TBD		3,500
GAS 20	20	Flanged	107	70	12,000	TBD		TBD		5,000
GAS 22	22	Flanged	126	70	15,000	TBD		TBD		5,500
GAS 24	24	Flanged	144	82	17,000	TBD		TBD		7,000

* Velocity rates are available as high as 10 ft./sec., but 6 ft./sec. is the optimum for air elimination.

Air Vent Valve

Model Sizes	Air Vent Valve (Inches)		Height (Inches)	Width (Inches)		Part Number		Shipping Weight (lbs)
747 Air Vent	3/4		9 1/2	4 1/4		TBD		8

No Anchor Clips

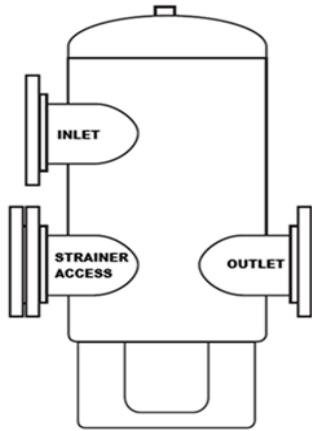

With Anchor Clips

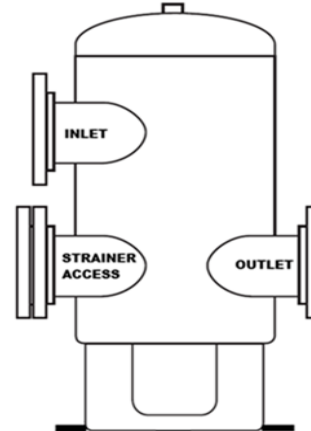

- Notes:
- 1) Shell & Heads: Carbon Steel; Max Temp: 350° F.
 - 2) Exterior: Primer & Black Paint Finish.
 - 3) Maximum Working Pressure: 125 PISG.

AIR, DIRT, HYDRAULIC SEPARATORS

AIR SEPARATORS

GRUNDFOS AIR SEPARATORS - COALESCING, GASF MODELS

Standard Velocity / Fixed Head

Model Sizes	Pipe Size (Inches)	Connection	*Height (Inches)	Width (Inches)	With Options ("W")		Less Options ("X")		Shipping Weight (lbs)
					**Flow (GPM)	Part Number	Part Number		
GASF-020	2"	Flanged	25	15 1/4	65	TBD		TBD	150
GASF-025	2.5"	Flanged	26	15 3/4	95	TBD		TBD	150
GASF-030	3"	Flanged	29	20 1/4	150	TBD		TBD	150
GASF-040	4"	Flanged	30 1/2	20 5/8	250	TBD		TBD	250
GASF-050	5"	Flanged	36	27 3/4	380	TBD		TBD	310
GASF-060	6"	Flanged	38	27 3/4	560	TBD		TBD	375
GASF-080	8"	Flanged	47	33 5/8	970	TBD		TBD	700
GASF-100	10"	Flanged	55	37 1/2	1,510	TBD		TBD	1,000
GASF-120	12"	Flanged	63	42 1/2	2,130	TBD		TBD	1,500
GASF-140	14"	Flanged	71 3/8	45	2,880	TBD		N/A	1,670
GASF-160	16"	Flanged	92 3/8	50	3,760	TBD		N/A	2,045
GASF-180	18"	Flanged	89	56	4,760	TBD		N/A	2,800
GASF-200	20"	Flanged	116	61 1/2	5,880	TBD		N/A	4,125
GASF-240	24"	Flanged	114	72	8,460	TBD		N/A	6,370

* Height does not include the ball valve on the bottom of the separator.

** Velocity rates are available as high as 10 ft./sec., but 6 ft./sec. is the optimum for air elimination.

Standard Equipment: Air Vent, Flanged Connections, Blowdown Valve, Skim Valve, and Fixed Head.

Options: (2) Sight Glass and (2) Gauge Taps.

With Options

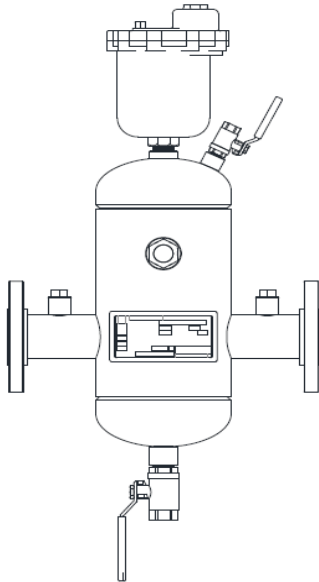

Less Options

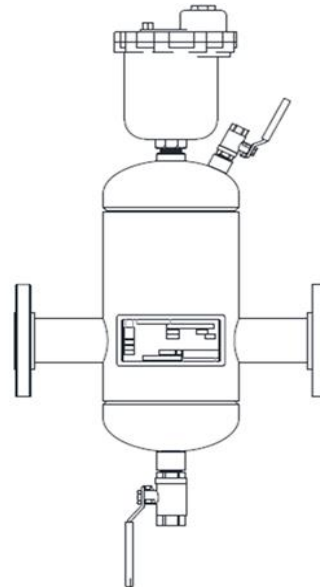

- Notes:
- 1) Shell & Heads: Carbon Steel; Max Temp: 375° F.
 - 2) Exterior: Primer & Black Paint Finish.
 - 3) Maximum Working Pressure: 2" to 12 is 175 PSIG; 14" to 24" is 150 PSIG.

AIR, DIRT, HYDRAULIC SEPARATORS

AIR SEPARATORS

GRUNDFOS AIR SEPARATORS - COALESCING, GAHF MODELS

High Velocity / Fixed Head

Model Sizes	Pipe Size (Inches)	Connection	*Height (Inches)	Width (Inches)	With Options ("W")		Less Options ("X")		Shipping Weight (lbs)
					**Flow (GPM)	Part Number	Part Number		
GAHF-020	2"	Flanged	31	15 1/4	105	TBD		TBD	175
GAHF-025	2.5"	Flanged	32	15 3/4	155	TBD		TBD	175
GAHF-030	3"	Flanged	36	20 1/4	225	TBD		TBD	175
GAHF-040	4"	Flanged	37 1/2	20 5/8	405	TBD		TBD	275
GAHF-050	5"	Flanged	48	27 3/4	630	TBD		TBD	475
GAHF-060	6"	Flanged	49	27 3/4	910	TBD		TBD	525
GAHF-080	8"	Flanged	58	33 5/8	1,610	TBD		TBD	825
GAHF-100	10"	Flanged	71	37 1/2	2,450	TBD		TBD	1,275
GAHF-120	12"	Flanged	86	42 1/2	3,500	TBD		TBD	2,050
GAHF-140	14"	Flanged	92 3/8	45	4,650	TBD		N/A	2,170
GAHF-160	16"	Flanged	113 3/8	50	6,050	TBD		N/A	2,945
GAHF-180	18"	Flanged	116	56	7,600	TBD		N/A	3,900
GAHF-200	20"	Flanged	146	61 1/2	9,400	TBD		N/A	5,825
GAHF-240	24"	Flanged	150	72	13,500	TBD		N/A	9,070

* Height does not include the ball valve on the bottom of the separator.

** Velocity rates are available as high as 10 ft./sec., but 6 ft./sec. is the optimum for air elimination.

Standard Equipment: Air Vent, Flanged Connections, Blowdown Valve, Skim Valve, and Fixed Head.

Options: (2) Sight Glass and (2) Gauge Taps.

With Options

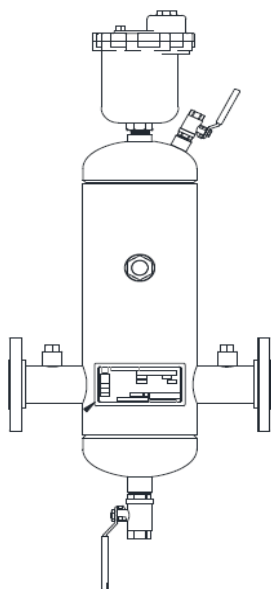

Less Options

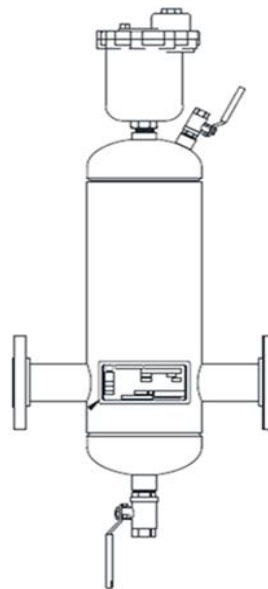

- Notes:
- 1) Shell & Heads: Carbon Steel; Max Temp: 375° F.
 - 2) Exterior: Primer & Black Paint Finish.
 - 3) Maximum Working Pressure: 2" to 12" is 175 PSIG; 14" to 24" is 150 PSIG.

AIR, DIRT, HYDRAULIC SEPARATORS

AIR & DIRT SEPARATORS

GRUNDFOS AIR & DIRT SEPARATORS - COALESCING, GBSF MODELS

Standard Velocity / Fixed Head

Model Sizes	Pipe Size (Inches)	Connection	*Height (Inches)	Width (Inches)	With Options ("W")		Less Options ("X")		Shipping Weight (lbs)
					**Flow (GPM)	Part Number	Part Number		
GBSF-020	2"	Flanged	25	15 1/4	65	TBD	TBD	TBD	120
GBSF-025	2.5"	Flanged	26	15 3/4	95	TBD	TBD	TBD	120
GBSF-030	3"	Flanged	29	20 1/4	150	TBD	TBD	TBD	120
GBSF-040	4"	Flanged	30 1/2	20 5/8	250	TBD	TBD	TBD	200
GBSF-050	5"	Flanged	36	27 3/4	380	TBD	TBD	TBD	240
GBSF-060	6"	Flanged	38	27 3/4	560	TBD	TBD	TBD	265
GBSF-080	8"	Flanged	47	33 5/8	970	TBD	TBD	TBD	530
GBSF-100	10"	Flanged	55	37 1/2	1,510	TBD	TBD	TBD	730
GBSF-120	12"	Flanged	63	42 1/2	2,130	TBD	TBD	TBD	1,110
GBSF-140	14"	Flanged	71 3/8	45	2,880	TBD	N/A	N/A	1,670
GBSF-160	16"	Flanged	92 3/8	50	3,760	TBD	N/A	N/A	2,045
GBSF-180	18"	Flanged	89	56	4,760	TBD	N/A	N/A	2,800
GBSF-200	20"	Flanged	116	61 1/2	5,880	TBD	N/A	N/A	4,125
GBSF-240	24"	Flanged	114	72	8,460	TBD	N/A	N/A	6,370

* Height does not include the ball valve on the bottom of the separator.

** Velocity rates are available as high as 10 ft./sec., but 6 ft./sec. is the optimum for air elimination.

Standard Equipment: Air Vent, Flanged Connections, Blowdown Valve, Skim Valve, and Fixed Head.

Options: (2) Sight Glass and (2) Gauge Taps.

With Options

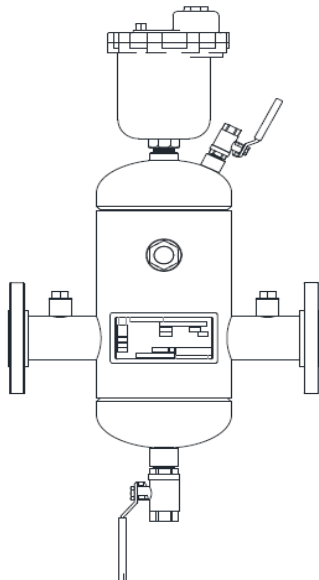

Less Options

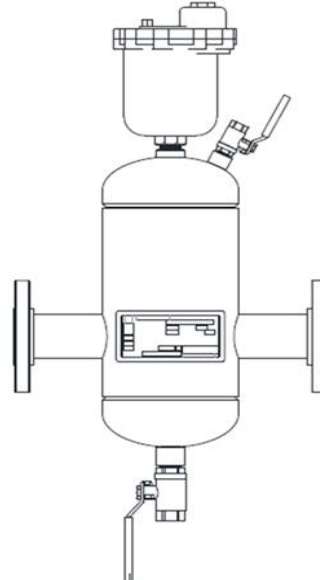

- Notes:
- 1) Shell & Heads: Carbon Steel; Max Temp: 375° F.
 - 2) Exterior: Primer & Black Paint Finish.
 - 3) Maximum Working Pressure: 2" to 12" is 175 PSIG; 14" to 24" is 150 PSIG.

AIR, DIRT, HYDRAULIC SEPARATORS

AIR & DIRT SEPARATORS

GRUNDFOS AIR & DIRT SEPARATORS - COALESCING, GBHF MODELS

High Velocity / Fixed Head

Model Sizes	Pipe Size (Inches)	Connection	*Height (Inches)	Width (Inches)	With Options ("W")		Less Options ("X")		Shipping Weight (lbs)
					**Flow (GPM)	Part Number	Part Number		
GBHF-020	2"	Flanged	31	15 1/4	105	TBD		TBD	125
GBHF-025	2.5"	Flanged	32	15 3/4	155	TBD		TBD	125
GBHF-030	3"	Flanged	36	20 1/4	225	TBD		TBD	150
GBHF-040	4"	Flanged	37 1/2	20 5/8	405	TBD		TBD	225
GBHF-050	5"	Flanged	48	27 3/4	630	TBD		TBD	410
GBHF-060	6"	Flanged	49	27 3/4	910	TBD		TBD	460
GBHF-080	8"	Flanged	58	33 5/8	1,610	TBD		TBD	675
GBHF-100	10"	Flanged	71	37 1/2	2,450	TBD		TBD	1,000
GBHF-120	12"	Flanged	86	42 1/2	3,500	TBD		TBD	1,675
GBHF-140	14"	Flanged	92 3/8	45	4,650	TBD		N/A	2,170
GBHF-160	16"	Flanged	113 3/8	50	6,050	TBD		N/A	2,945
GBHF-180	18"	Flanged	116	56	7,600	TBD		N/A	3,900
GBHF-200	20"	Flanged	146	61 1/2	9,400	TBD		N/A	5,825
GBHF-240	24"	Flanged	150	72	13,500	TBD		N/A	9,070

* Height does not include the ball valve on the bottom of the separator.

** Velocity rates are available as high as 10 ft./sec., but 6 ft./sec. is the optimum for air elimination.

Standard Equipment: Air Vent, Flanged Connections, Blowdown Valve, Skim Valve, and Fixed Head.

Options: (2) Sight Glass and (2) Gauge Taps.

With Options

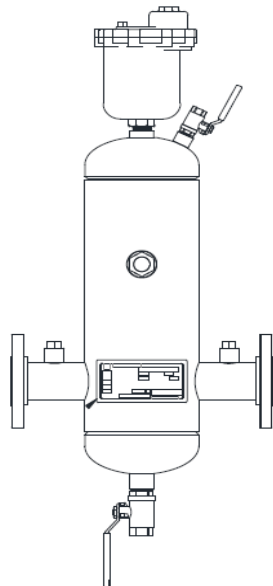

Less Options

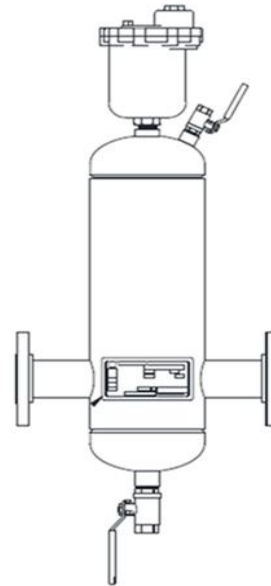

- Notes:
- 1) Shell & Heads: Carbon Steel; Max Temp: 375° F.
 - 2) Exterior: Primer & Black Paint Finish.
 - 3) Maximum Working Pressure: 2" to 12 is 175 PSIG; 14" to 24" is 150 PSIG.

AIR, DIRT, HYDRAULIC SEPARATORS

AIR & DIRT SEPARATORS

GRUNDFOS AIR & DIRT SEPARATORS - COALESCING, GBSR MODELS

Standard Velocity / Removable Head

Model Sizes	Pipe Size (Inches)	Connection	*Height (Inches)	Width (Inches)	With Options ("W")		Less Options ("X")		Shipping Weight (lbs)
					**Flow (GPM)	Part Number	Part Number		
GBSR-020	2"	Flanged	32 1/2	15 1/4	65	TBD	TBD	TBD	150
GBSR-025	2.5"	Flanged	32 1/2	15 3/4	95	TBD	TBD	TBD	150
GBSR-030	3"	Flanged	32 1/2	20 1/4	150	TBD	TBD	TBD	150
GBSR-040	4"	Flanged	37	20 5/8	250	TBD	TBD	TBD	250
GBSR-050	5"	Flanged	47	27 3/4	380	TBD	TBD	TBD	310
GBSR-060	6"	Flanged	49	27 3/4	560	TBD	TBD	TBD	375
GBSR-080	8"	Flanged	57	33 5/8	970	TBD	TBD	TBD	700
GBSR-100	10"	Flanged	71	37 1/2	1,510	TBD	TBD	TBD	1,000
GBSR-120	12"	Flanged	86	42 1/2	2,130	TBD	TBD	TBD	1,500
GBSR-140	14"	Flanged	102	45	2,880	TBD	N/A	N/A	1,950
GBSR-160	16"	Flanged	126	50	3,760	TBD	N/A	N/A	2,325
GBSR-180	18"	Flanged	129	56	4,760	TBD	N/A	N/A	3,250
GBSR-200	20"	Flanged	153	61 1/2	5,880	TBD	N/A	N/A	4,575
GBSR-240	24"	Flanged	158	72	8,460	TBD	N/A	N/A	7,250

* Height does not include the ball valve on the bottom of the separator.

** Velocity rates are available as high as 10 ft./sec., but 6 ft./sec. is the optimum for air elimination.

Standard Equipment: Air Vent, Flanged Connections, Blowdown Valve, Skim Valve, and Removable Head.

Options: (4) Sight Glass and (2) Gauge Taps.

With Options

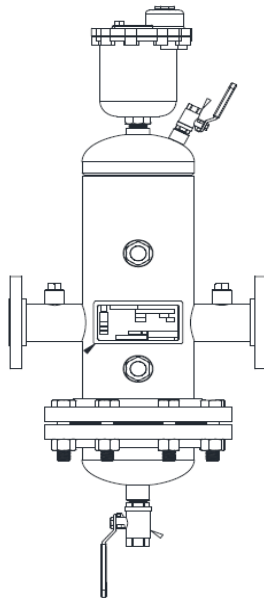

Less Options

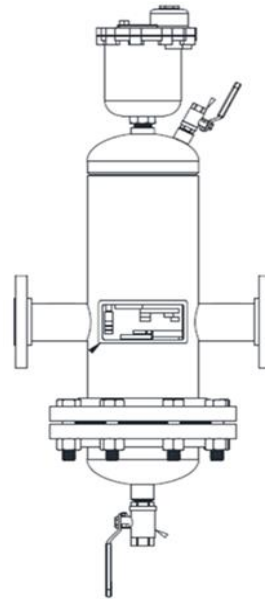

- Notes:
- 1) Shell & Heads: Carbon Steel; Max Temp: 375° F.
 - 2) Exterior: Primer & Black Paint Finish.
 - 3) Maximum Working Pressure: 2" to 12 is 175 PSIG; 14" to 24" is 150 PSIG.
 - 4) If Required, the Lower Head and Coalescing Media are Removable for Cleaning.

AIR, DIRT, HYDRAULIC SEPARATORS

AIR & DIRT SEPARATORS

GRUNDFOS AIR & DIRT SEPARATORS - COALESCING, GBHR MODELS

High Velocity / Removable Head

Model Sizes	Pipe Size (Inches)	Connection	*Height (Inches)	Width (Inches)	With Options ("W")		Less Options ("X")		Shipping Weight (lbs)
					**Flow (GPM)	Part Number	Part Number		
GBHR-020	2"	Flanged	31	15 1/4	105	TBD		TBD	150
GBHR-025	2.5"	Flanged	32	15 3/4	155	TBD		TBD	150
GBHR-030	3"	Flanged	36	20 1/4	225	TBD		TBD	175
GBHR-040	4"	Flanged	37 1/2	20 5/8	405	TBD		TBD	275
GBHR-050	5"	Flanged	48	27 3/4	630	TBD		TBD	475
GBHR-060	6"	Flanged	49	27 3/4	910	TBD		TBD	525
GBHR-080	8"	Flanged	58	33 5/8	1,610	TBD		TBD	825
GBHR-100	10"	Flanged	71	37 1/2	2,450	TBD		TBD	1,275
GBHR-120	12"	Flanged	86	42 1/2	3,500	TBD		TBD	2,050
GBHR-140	14"	Flanged	92 3/8	45	4,650	TBD		N/A	2,450
GBHR-160	16"	Flanged	113 3/8	50	6,050	TBD		N/A	3,225
GBHR-180	18"	Flanged	116	56	7,600	TBD		N/A	4,350
GBHR-200	20"	Flanged	146	61 1/2	9,400	TBD		N/A	6,275
GBHR-240	24"	Flanged	150	72	13,500	TBD		N/A	9,950

* Height does not include the ball valve on the bottom of the separator.

** Velocity rates are available as high as 10 ft./sec., but 6 ft./sec. is the optimum for air elimination.

Standard Equipment: Air Vent, Flanged Connections, Blowdown Valve, Skim Valve, and Removable Head.

Options: (4) Sight Glass and (2) Gauge Taps.

With Options

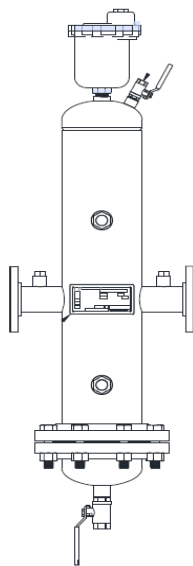

Less Options

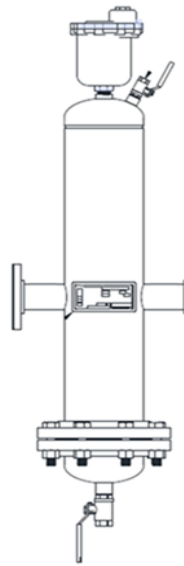

- Notes:
- 1) Shell & Heads: Carbon Steel; Max Temp: 375° F.
 - 2) Exterior: Primer & Black Paint Finish.
 - 3) Maximum Working Pressure: 2" to 12 is 175 PSIG; 14" to 24" is 150 PSIG.
 - 4) If Required, the Lower Head and Coalescing Media are Removable for Cleaning.

AIR, DIRT, HYDRAULIC SEPARATORS

HYDRAULIC SEPARATORS WITH AIR & DIRT ELIMINATION

GRUNDFOS HYDRAULIC SEPARATORS - COALESCING, G4SF MODELS

Standard Velocity / Fixed Head

Model Sizes	Pipe Size (Inches)	Connection	*Height (Inches)	Width (Inches)	With Options ("W")		Less Options ("X")		Shipping Weight (lbs)
					**Flow (GPM)	Part Number	Part Number		
G4SF-020	2"	Flanged	37	15 1/4	65	CF		TBD	80
G4SF-025	2.5"	Flanged	37	15 3/4	95	CF		TBD	110
G4SF-030	3"	Flanged	37	20 1/4	150	CF		TBD	165
G4SF-040	4"	Flanged	46	20 5/8	250	CF		TBD	260
G4SF-050	5"	Flanged	56	27 3/4	380	TBD		TBD	435
G4SF-060	6"	Flanged	65	27 3/4	560	113012-01		TBD	470
G4SF-080	8"	Flanged	84	33 5/8	970	TBD		TBD	760
G4SF-100	10"	Flanged	102	37 1/2	1,510	TBD		TBD	1,160
G4SF-120	12"	Flanged	120	42 1/2	2,130	TBD		CF	1,835

* Height does not include the ball valve on the bottom of the separator.

** Velocity rates are available as high as 10 ft./sec., but 6 ft./sec. is the optimum for air elimination.

Standard Equipment: Air Vent, Flanged Connections, Blowdown Valve, Skim Valve, and Fixed Head.

Options: (4) Sight Glass and (4) Gauge Taps.

With Options

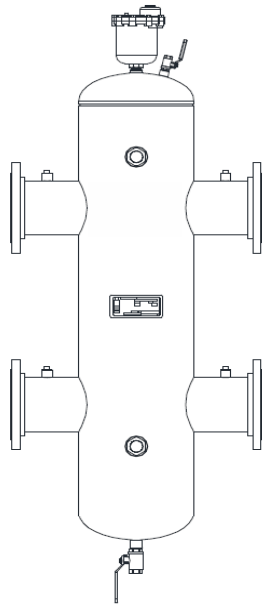

Less Options

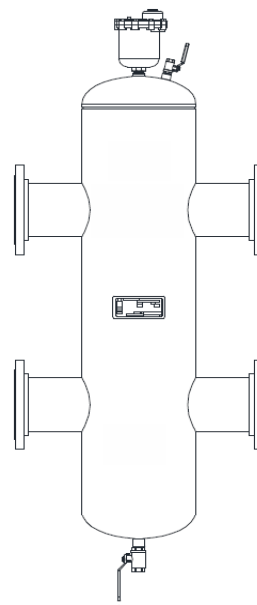

- Notes:
- 1) Shell & Heads: Carbon Steel; Max Temp: 375° F.
 - 2) Exterior: Primer & Black Paint Finish.
 - 3) Maximum Working Pressure: 175 PSIG.

AIR, DIRT, HYDRAULIC SEPARATORS

HYDRAULIC SEPARATORS WITH AIR & DIRT ELIMINATION

GRUNDFOS HYDRAULIC SEPARATORS - COALESCING, G4SR MODELS

Standard Velocity / Removable Head

Model Sizes	Pipe Size (Inches)	Connection	*Height (Inches)	Width (Inches)	With Options ("W")		Less Options ("X")		Shipping Weight (lbs)
					**Flow (GPM)	Part Number	Part Number		
G4SR-020	2"	Flanged	37	15 1/4	65	CF		TBD	110
G4SR-025	2.5"	Flanged	37	15 3/4	95	CF		TBD	140
G4SR-030	3"	Flanged	37	20 1/4	150	CF		TBD	195
G4SR-040	4"	Flanged	46	20 5/8	250	TBD		TBD	310
G4SR-050	5"	Flanged	56	27 3/4	380	TBD		TBD	505
G4SR-060	6"	Flanged	65	27 3/4	560	TBD		TBD	580
G4SR-080	8"	Flanged	84	33 5/8	970	TBD		TBD	940
G4SR-100	10"	Flanged	102	37 1/2	1,510	TBD		TBD	1,440
G4SR-120	12"	Flanged	120	42 1/2	2,130	TBD		TBD	2,225

* Height does not include the ball valve on the bottom of the separator.

** Velocity rates are available as high as 10 ft./sec., but 6 ft./sec. is the optimum for air elimination.

Standard Equipment: Air Vent, Flanged Connections, Blowdown Valve, Skim Valve, and Removable Head.

Options: (4) Sight Glass and (4) Gauge Taps.

With Options

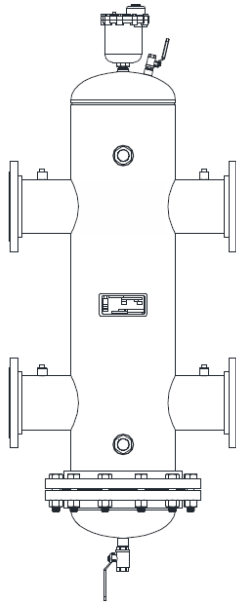

Less Options

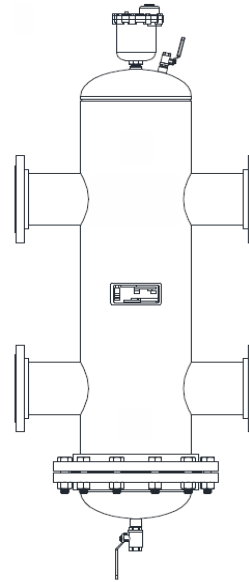

- Notes:
- 1) Shell & Heads: Carbon Steel; Max Temp: 375° F.
 - 2) Exterior: Primer & Black Paint Finish.
 - 3) Maximum Working Pressure: 175 PSIG.

AIR, DIRT, HYDRAULIC SEPARATORS

HYDRAULIC SEPARATORS WITH AIR & DIRT ELIMINATION

[4] SPIROVENT QUAD HYDRAULIC SEPARATORS - COALESCING, VDX MODELS

Male Threaded Connections / Fixed Head

Non-ASME Model Sizes	Pipe Size (Inches)	Connection	*Height (Inches)	Width (Inches)	**Flow (GPM)	Male Thrd / Fixed Hd		Shipping Weight (lbs)
						Part Number		
VDX200MT	2"	Threaded	32	15	60	TBD		56
VDX250MT	2.5"	Threaded	36	15	90	TBD		64
VDX300MT	3"	Threaded	39	20	140	TBD		106
VDX400MT	4"	Threaded	50	20	240	TBD		137

Flanged Connections / Fixed Head

Model Sizes	Pipe Size (Inches)	Connection	*Height (Inches)	Width (Inches)	**Flow (GPM)	Flanged / Fixed Head		Shipping Weight (lbs)
						Part Number		
VDX200FA	2"	Flanged	32	15	60	TBD		80
VDX250FA	2.5"	Flanged	36	15	90	TBD		96
VDX300FA	3"	Flanged	39	20	140	110853-01		146
VDX400FA	4"	Flanged	50	20	240	TBD		197
VDX500FA	5"	Flanged	61	26	370	TBD		273
VDX600FA	6"	Flanged	70	26	540	TBD		323
VDX800FA	8"	Flanged	91	32	940	TBD		622
VDX1000FA	10"	Flanged	113	36	1,470	TBD		978
VDX1200FA	12"	Flanged	133	42	2,090	TBD		1,747

Flanged Connections / Fixed Head with Magnet

Model Sizes	Pipe Size (Inches)	Connection	*Height (Inches)	Width (Inches)	**Flow (GPM)	Flanged w/ Magnet		Shipping Weight (lbs)
						Part Number		
VDX200FAM	2"	Flanged	32	15	60	TBD		90
VDX250FAM	2.5"	Flanged	36	15	90	TBD		106
VDX300FAM	3"	Flanged	39	20	140	110853-01		156
VDX400FAM	4"	Flanged	50	20	240	TBD		207
VDX500FAM	5"	Flanged	61	26	370	TBD		283
VDX600FAM	6"	Flanged	70	26	540	TBD		333
VDX800FAM	8"	Flanged	91	32	940	TBD		642
VDX1000FAM	10"	Flanged	113	36	1,470	TBD		998
VDX1200FAM	12"	Flanged	133	42	2,090	TBD		1,767

* Height does not include the ball valve on the bottom of the separator.

** Velocity rates are 6 ft./sec. for optimum for air elimination.

Standard Equipment: Air Vent, Flanged Connections, Blowdown Valve, Air Vent Valve, and Fixed Head (Magnet with FAM Models).

Male Threaded or Flanged Models

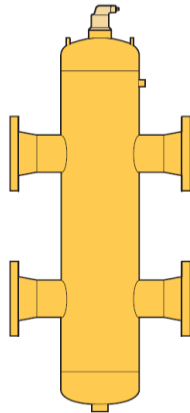

Flanged with Magnet Models

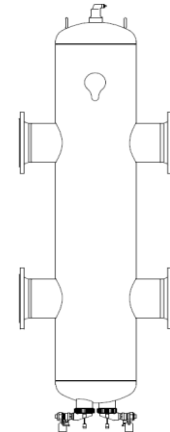
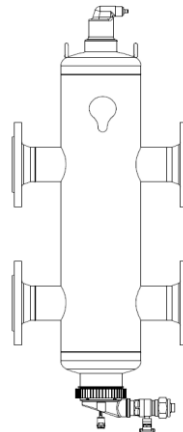

- Notes:
- 1) Shell & Heads: Carbon Steel; Max Temp: 270° F.
 - 2) Exterior: Primer & Yellow Paint Finish.
 - 3) Maximum Working Pressure: 150 PSIG.
 - 4) Spirovent Quad models are to be sold with a Boiler and NOT as a stand-alone sale.

AIR, DIRT, HYDRAULIC SEPARATORS

HYDRAULIC SEPARATORS WITH AIR & DIRT ELIMINATION

[4] SPIROVENT QUAD HYDRAULIC SEPARATORS - COALESCING, VXN MODELS

Flanged Connections / Removable Head

Model Sizes	Pipe Size (Inches)	Connection	*Height (Inches)	Width (Inches)	**Flow (GPM)	Flgd / Removable Hd		Shipping Weight (lbs)
						Part Number		
VXN200FA	2"	Flanged	37	15 1/4	65	TBD		142
VXN250FA	2.5"	Flanged	37	15 3/4	95	TBD		160
VXN300FA	3"	Flanged	37	20 1/4	150	TBD		242
VXN400FA	4"	Flanged	46	20 5/8	250	TBD		281
VXN500FA	5"	Flanged	56	27 3/4	380	TBD		433
VXN600FA	6"	Flanged	65	27 3/4	560	TBD		518
VXN800FA	8"	Flanged	84	33 5/8	970	TBD		848
VXN1000FA	10"	Flanged	102	37 1/2	1,510	TBD		1,380
VXN1200FA	12"	Flanged	120	42 1/2	2,130	TBD		2,127

* Height does not include the ball valve on the bottom of the separator.

** Velocity rates are 6 ft./sec. for optimum for air elimination.

Standard Equipment: Air Vent, Flanged Connections, Blowdown Valve, Air Vent Valve, and Removable Head.

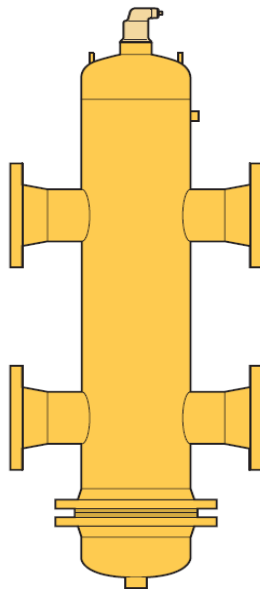

- Notes:
- 1) Shell & Heads: Carbon Steel; Max Temp: 270° F.
 - 2) Exterior: Primer & Yellow Paint Finish.
 - 3) Maximum Working Pressure: 150 PSIG.
 - 4) Spirovent Quad models are to be sold with a Boiler and NOT as a stand-alone sale.

AIR, DIRT, HYDRAULIC SEPARATORS

AIR / DIRT / HYDRAULIC SEPARATORS

MULTIPLE UNITS COMMON HOT WATER PIPING SIZING

Amp Boiler Models	Number of Units						
	2	3	4	5	6	7	8
	(NPS) Pipe Sizes (Based on 20°F ΔT)						
AMP-400	2.5"	4"	4"	5"	5"	5"	5"
AMP-500	3"	4"	5"	5"	6"	6"	6"
AMP-650	4"	5"	5"	6"	6"	6"	6"
AMP-800	4"	5"	6"	6"	8"	8"	8"
AMP-1000	4"	5"	6"	8"	8"	8"	8"
AMP-1250	5"	6"	8"	8"	8"	8"	10"
AMP-1500	5"	8"	8"	8"	10"	10"	10"
AMP-2000	6"	8"	8"	10"	10"	10"	12"
AMP-2500	6"	8"	10"	10"	12"	12"	12"
AMP-3000	8"	10"	10"	12"	12"	12"	14"
AMP-3500	8"	10"	12"	12"	14"	14"	14"
AMP-4000	8"	10"	12"	12"	14"	14"	14"

Arctic Boiler Models	Number of Units						
	2	3	4	5	6	7	8
	(NPS) Pipe Sizes (Based on 20°F ΔT)						
ARC-1000	3"	3.5"	4"	5"	5"	6"	6"
ARC-1500	3.5"	4"	5"	6"	6"	8"	8"
ARC-2000	4"	5"	6"	6"	8"	8"	8"
ARC-2500	5"	6"	6"	8"	8"	8"	10"
ARC-3000	5"	6"	8"	8"	10"	10"	10"
ARC-3500	5"	8"	8"	8"	10"	10"	12"
ARC-4000	6"	8"	8"	10"	10"	12"	12"
ARC-4500	6"	8"	10"	10"	10"	12"	12"
ARC-5000	6"	8"	10"	10"	12"	12"	14"
ARC-6000	8"	10"	10"	12"	12"	14"	14"

Evolution Product Models	Number of Units						
	2	3	4	5	6	7	8
	(NPS) Pipe Sizes (Based on 20°F ΔT)						
EV-500	3"	4"	4"	5"	5"	5"	6"
EV-750	3"	4"	5"	5"	6"	6"	8"
EV-1000	4"	5"	5"	6"	8"	8"	8"
EV-1500	5"	6"	8"	8"	8"	10"	10"
EV-2000	6"	8"	8"	10"	10"	10"	12"
EV-2000S	6"	8"	8"	10"	10"	10"	12"
EV-2500	6"	8"	10"	10"	10"	12"	12"
EV-3000	8"	8"	10"	10"	12"	12"	14"

Notes:

1. These are suggested piping configurations. It is the installer's responsibility to conform to local codes and ordinances for additional requirements.
2. Pressure relief valve rating shall not exceed pressure rating of any component in the system.
3. It is the installer's responsibility to select piping configurations that provide the proper flow rates and performance.
4. Erosion could occur if common piping is undersized.

BUFFER TANKS

CHILLED WATER BUFFER TANKS

GRUNDFOS CHILLED WATER BUFFER TANKS, GCWBT MODELS

Model Sizes	Capacity (Gallons)	Inlet/Outlet Connections (Inches)	Height (Inches)	Diameter (Inches)	No Anchor Clips		With Anchor Clips		Shipping Weight (lbs)
					Part Number		Part Number		
GCWBT-120-3F	120	3" Flanged	55 3/4	24	TBD		TBD		294
GCWBT-120-4F	120	4" Flanged	55 3/4	24	TBD		TBD		315
GCWBT-120-6F	120	6" Flanged	55 3/4	24	TBD		TBD		333
GCWBT-200-3F	200	3" Flanged	62 3/8	30	TBD		TBD		527
GCWBT-200-4F	200	4" Flanged	62 3/8	30	TBD		TBD		547
GCWBT-200-6F	200	6" Flanged	62 3/8	30	TBD		TBD		566
GCWBT-300-3F	300	3" Flanged	80 3/8	36	TBD		TBD		724
GCWBT-300-4F	300	4" Flanged	80 3/8	36	TBD		TBD		753
GCWBT-300-6F	300	6" Flanged	80 3/8	36	TBD		TBD		772
GCWBT-300-8F	300	8" Flanged	80 3/8	36	TBD		TBD		801
GCWBT-500-4F	500	4" Flanged	99 1/2	42	TBD		TBD		1,283
GCWBT-500-6F	500	6" Flanged	99 1/2	42	TBD		TBD		1,366
GCWBT-500-8F	500	8" Flanged	99 1/2	42	TBD		TBD		1,395
GCWBT-500-10F	500	10" Flanged	99 1/2	42	TBD		TBD		1,490
GCWBT-850-4F	850	4" Flanged	114 7/16	54	TBD		TBD		2,604
GCWBT-850-6F	850	6" Flanged	114 7/16	54	TBD		TBD		2,707
GCWBT-850-8F	850	8" Flanged	114 7/16	54	TBD		TBD		2,736
GCWBT-850-10F	850	10" Flanged	114 7/16	54	TBD		TBD		2,771
GCWBT-1040-4F	1,040	4" Flanged	107 7/8	60	TBD		TBD		2,976
GCWBT-1040-6F	1,040	6" Flanged	107 7/8	60	TBD		TBD		3,090
GCWBT-1040-8F	1,040	8" Flanged	107 7/8	60	TBD		TBD		3,136
GCWBT-1040-10F	1,040	10" Flanged	107 7/8	60	TBD		TBD		3,171
GCWBT-1040-12F	1,040	10" Flanged	107 7/8	60	N/A		TBD		3,171
GCWBT-1200-4F	1,200	4" Flanged	122 3/4	60	TBD		TBD		2,521
GCWBT-1200-6F	1,200	6" Flanged	122 3/4	60	TBD		TBD		2,542
GCWBT-1200-8F	1,200	8" Flanged	122 3/4	60	TBD		TBD		2,566
GCWBT-1200-10F	1,200	10" Flanged	122 3/4	60	TBD		TBD		2,602
GCWBT-1200-12F	1,200	10" Flanged	122 3/4	60	N/A		TBD		2,602
GCWBT-1500-4F	1,500	4" Flanged	108 1/8	72	TBD		TBD		3,010
GCWBT-1500-6F	1,500	6" Flanged	108 1/8	72	TBD		TBD		3,023
GCWBT-1500-8F	1,500	8" Flanged	108 1/8	72	TBD		TBD		3,053
GCWBT-1500-10F	1,500	10" Flanged	108 1/8	72	TBD		TBD		3,080
GCWBT-1500-12F	1,500	12" Flanged	108 1/8	72	TBD		TBD		3,100
GCWBT-2000-4F	2,000	4" Flanged	TBD	TBD	TBD		TBD		4,224
GCWBT-2000-6F	2,000	6" Flanged	TBD	TBD	TBD		TBD		4,238
GCWBT-2000-8F	2,000	8" Flanged	TBD	TBD	TBD		TBD		4,268
GCWBT-2000-10F	2,000	10" Flanged	TBD	TBD	TBD		TBD		TBD
GCWBT-2000-12F	2,000	12" Flanged	TBD	TBD	TBD		TBD		TBD
GCWBT-2500-4F	2,500	4" Flanged	TBD	TBD	TBD		TBD		TBD
GCWBT-2500-6F	2,500	6" Flanged	TBD	TBD	TBD		TBD		TBD
GCWBT-2500-8F	2,500	8" Flanged	TBD	TBD	TBD		TBD		TBD
GCWBT-2500-10F	2,500	10" Flanged	TBD	TBD	TBD		TBD		TBD
GCWBT-2500-12F	2,500	12" Flanged	TBD	TBD	TBD		TBD		TBD
GCWBT-3000-4F	3,000	4" Flanged	TBD	TBD	TBD		TBD		TBD
GCWBT-3000-6F	3,000	6" Flanged	TBD	TBD	TBD		TBD		TBD
GCWBT-3000-8F	3,000	8" Flanged	TBD	TBD	TBD		TBD		TBD
GCWBT-3000-10F	3,000	10" Flanged	TBD	TBD	TBD		TBD		TBD
GCWBT-3000-12F	3,000	12" Flanged	TBD	TBD	TBD		TBD		TBD

No Anchor Clips

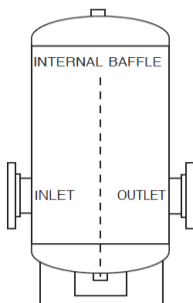

With Anchor Clips

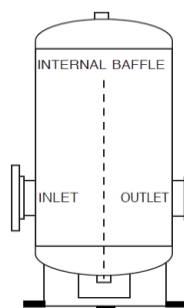

- Notes:
- 1) Shell & Heads: Carbon Steel; Max Temp: 450° F.
 - 2) Exterior: Primer & Black Paint Finish.
 - 3) Maximum Working Pressure: 125 PSIG.
 - 4) Top Vent Connection and Bottom Drain Connection.

BUFFER TANKS

CHILLED WATER BUFFER TANKS

THERMAL SOLUTIONS CHILLED WATER BUFFER TANKS, TSCB MODELS

Model Sizes	Capacity (Gallons)	Inlet / Outlet *Connections (Inches)	Height (Inches)	Diameter (Inches)	Bare Tank		Shipping Weight (lbs)
					Part Number		
TSCB-130	130	2" NPT	76"	24"	TBD		375
TSCB-210	210	3" Flanged	79"	30"	TBD		425
TSCB-285	285	4" Flanged	76"	36"	TBD		633
TSCB-360	360	4" Flanged	98"	36"	TBD		715
TSCB-385	385	4" Flanged	88"	42"	TBD		1,250
TSCB-453	453	4" Flanged	88"	42"	TBD		1,275
TSCB-500	500	4" Flanged	94"	42"	TBD		1,300
TSCB-550	550	4" Flanged	104"	42"	TBD		1,425
TSCB-500	500	6" Flanged	81"	48"	TBD		1,150
TSCB-580	580	6" Flanged	88"	48"	TBD		1,425
TSCB-675	675	6" Flanged	103"	48"	TBD		1,885
TSCB-1000	1,000	6" Flanged	145"	48"	TBD		1,957
TSCB-850	850	6" Flanged	102"	54"	TBD		1,630
TSCB-1340	1,340	6" Flanged	163"	54"	TBD		2,800
TSCB-1500	1,500	6" Flanged	161"	54"	TBD		3,100
TSCB-1000	1,000	8" Flanged	102"	60"	TBD		2,280
TSCB-1515	1,515	8" Flanged	142"	60"	TBD		3,375
TSCB-2000	2,000	8" Flanged	183"	60"	TBD		4,225

* Flanged 3" and Above

Options

Model Sizes	316L Stainless Steel Tank		Duplex Stainless Steel Tank		[5] Top Coat Adder		Epoxy-Lining Adder		Shipping Weight (lbs)
	Part Number		Part Number		Part Number		Part Number		
TSCB-130	N/A		N/A		TBD		TBD		Consult Factory for the Shipping Weight of any of these Options.
TSCB-210	TBD		TBD		TBD		TBD		
TSCB-285	TBD		TBD		TBD		TBD		
TSCB-360	TBD		TBD		TBD		TBD		
TSCB-385	TBD		TBD		TBD		TBD		
TSCB-453	TBD		TBD		TBD		TBD		
TSCB-500	TBD		TBD		TBD		TBD		
TSCB-550	TBD		TBD		TBD		TBD		
TSCB-500	TBD		TBD		TBD		TBD		
TSCB-580	TBD		TBD		TBD		TBD		
TSCB-675	TBD		TBD		TBD		TBD		
TSCB-1000	TBD		TBD		TBD		TBD		
TSCB-850	N/A		N/A		TBD		TBD		
TSCB-1340	N/A		N/A		TBD		TBD		
TSCB-1500	N/A		N/A		TBD		TBD		
TSCB-1000	N/A		N/A		TBD		TBD		
TSCB-1515	N/A		N/A		TBD		TBD		
TSCB-2000	N/A		N/A		TBD		TBD		

Other Options Available:

1) Manway Available on 210 Gallon & Larger Tanks: Carbon Steel: \$2,244 List Price
 Stainless Steel: \$12,361 List Price

2) For Other Custom Options, Please Consult Factory for Details.

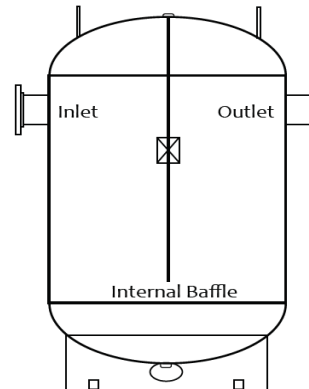

- Notes:
- 1) Shell & Heads: Carbon Steel - Max Temp: 400° F; Stainless Steel - Max Temp: 210° F.
 - 2) Exterior: Carbon Steel - Red Oxide Primer; Stainless Steel - No Exterior Primer.
 - 3) Maximum Working Pressure: Carbon Steel - 125 PSIG; Stainless Steel - 150 PSIG.
 - 4) Top Vent Connection, Bottom Drain Connection and Lifting Lugs.
 - 5) Top Coat is a Sprayed-On Rigid Insulation with Acrylic Top Coating that Exceeds ASHREE 90.1 Requirements with 2.25" of High-Density Polyurethane Foam with an "R" Value of R-16. SPF Meets Requirements for California Title 24. **The Top Coat can be used for Outdoor Use, too.**

BUFFER TANKS

HOT WATER BUFFER TANKS

GRUNDFOS HOT WATER BUFFER TANKS, GHWBT MODELS

2-Ports

Model Sizes	Capacity (Gallons)	Inlet/Outlet Connections (Inches)		Height (Inches)	Diameter (Inches)	Part Number		Shipping Weight (lbs)
GHWBT-120-2	120	2" Flanged		55 3/4	24	TBD		254
GHWBT-200-2	200	2" Flanged		62 1/2	30	TBD		475
GHWBT-300-2	300	2" Flanged		80 3/8	36	TBD		668
GHWBT-120-3	120	3" Flanged		55 3/4	24	TBD		268
GHWBT-200-3	200	3" Flanged		62 1/2	30	TBD		490
GHWBT-300-3	300	3" Flanged		80 3/8	36	TBD		683

4-Ports

Model Sizes	Capacity (Gallons)	Primary Inlet/Outlet Connections (Inches)	Secondary Inlet/Outlet Connections (Inches)	Height (Inches)	Diameter (Inches)	Part Number		Shipping Weight (lbs)
GHWBT-120-22	120	2" Flanged	2" Flanged	55 3/4	24	TBD		267
GHWBT-200-22	200	2" Flanged	2" Flanged	62 1/2	30	TBD		489
GHWBT-300-22	300	2" Flanged	2" Flanged	80 3/8	36	TBD		682
GHWBT-120-23	120	2" Flanged	3" Flanged	55 3/4	24	TBD		282
GHWBT-200-23	200	2" Flanged	3" Flanged	62 1/2	30	TBD		503
GHWBT-300-23	300	2" Flanged	3" Flanged	80 3/8	36	TBD		696
GHWBT-120-33	120	3" Flanged	3" Flanged	55 3/4	24	TBD		297
GHWBT-200-33	200	3" Flanged	3" Flanged	62 1/2	30	TBD		518
GHWBT-300-33	300	3" Flanged	3" Flanged	80 3/8	36	TBD		711
GHWBT-120-44	120	4" Flanged	4" Flanged	55 3/4	24	TBD		338
GHWBT-200-44	200	4" Flanged	4" Flanged	62 1/2	30	TBD		560
GHWBT-300-44	300	4" Flanged	4" Flanged	80 3/8	36	TBD		753

* Flanged

2-Ports Tanks

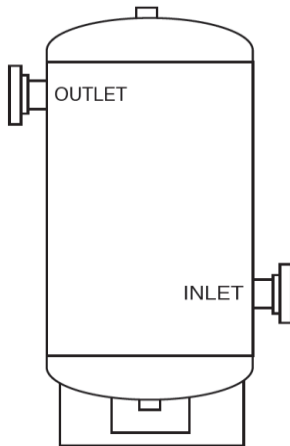

4-Ports Tanks

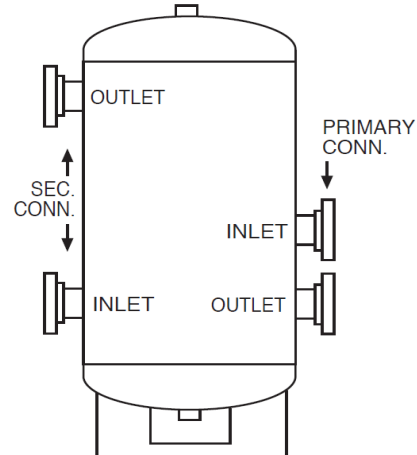

- Notes:
- 1) Shell & Heads: Carbon Steel; Max Temp: 450° F.
 - 2) Exterior: Black Primer.
 - 3) Maximum Working Pressure: 125 PSIG.
 - 4) Top Vent Connection and Bottom Drain Connection.

BUFFER TANKS

HOT WATER BUFFER TANKS

THERMAL SOLUTIONS HOT WATER BUFFER TANKS, TSHB MODELS

Model Sizes	Capacity (Gallons)	Inlet / Outlet Connections (Inches)	Height (Inches)	Diameter (Inches)	Bare Tank		Shipping Weight (lbs)
					Part Number		
TSHB-40	40	2" NPT	45"	18"	TBD		185
TSHB-80	80	3" NPT	45"	24"	TBD		310
TSHB-120	120	3" NPT	49"	30"	113531-09		310
TSHB-210	210	3" NPT	79"	30"	TBD		500
TSHB-285	285	4" Flanged	76"	36"	TBD		760
TSHB-385	385	6" Flanged	76"	42"	TBD		910
TSHB-453	453	6" Flanged	88"	42"	TBD		1,022
TSHB-675	675	6" Flanged	100"	48"	TBD		1,790
TSHB-860	860	6" Flanged	124"	48"	TBD		1,925
TSHB-1000	1,000	6" Flanged	100"	60"	TBD		2,280

Options

Model Sizes	316L Stainless Steel Tank		Duplex Stainless Steel Tank		[5] Top Coat Adder		Shipping Weight (lbs)
	Part Number		Part Number		Part Number		
TSHB-40	N/A		N/A		TBD		Consult Factory for the Shipping Weight of any of these Options.
TSHB-80	N/A		N/A		TBD		
TSHB-120	TBD		TBD		TBD		
TSHB-210	TBD		TBD		TBD		
TSHB-285	TBD		TBD		TBD		
TSHB-385	TBD		TBD		TBD		
TSHB-453	TBD		TBD		TBD		
TSHB-675	TBD		TBD		TBD		
TSHB-860	TBD		TBD		TBD		
TSHB-1000	TBD		TBD		TBD		

1) For Other Custom Options, Please Consult Factory for Details.

Threaded Connections

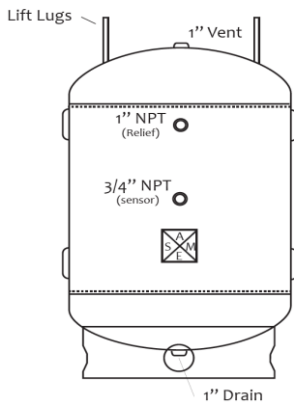

Flanged Connections

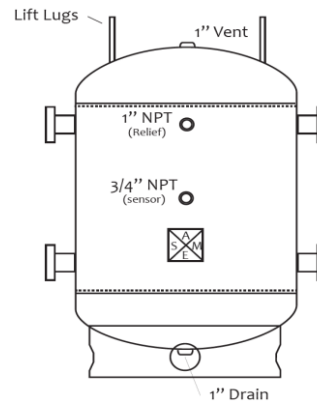

- Notes:
- 1) Shell & Heads: Carbon Steel - Max Temp: 400° F; Stainless Steel - Max Temp: 210° F.
 - 2) Exterior: Carbon Steel - Red Oxide Primer; Stainless Steel - No Exterior Primer.
 - 3) Maximum Working Pressure: Carbon Steel - 125 PSIG; Stainless Steel - 150 PSIG.
 - 4) Top Vent Connection, Bottom Drain Connection and Lifting Lugs.
 - 5) Top Coat is a Sprayed-On Rigid Insulation with Acrylic Top Coating that Exceeds ASHREE 90.1 Requirements with 2.25" of High-Density Polyurethane Foam with an "R" Value of R-16. SPF Meets Requirements for California Title 24. **The Top Coat can be used for Outdoor Use, too.**

BUFFER TANKS

HOT WATER BUFFER TANKS

^ H2OMAX HOT WATER BUFFER TANKS, B MODELS

Non-ASME Tanks

Model Sizes	Capacity (Gallons)	Overall Dimensions			Part Number	* Non-ASME	Shipping Weight (lbs)
		Height	Width	Depth			
B26	26	42"	19.5"	19.5"	106808-01		185
B48	48	45"	24.5"	24.5"	106808-02		310
B72	72	49"	26.5"	26.5"	106808-03		310
B119	119	60"	30.5"	30.5"	106808-04		500

* ASME stamped models available. Consult Factory.

Technical Information

Model Sizes	Capacity (Gallons)	Maximum Design		Connections	
		Boiler (MAWP)	Temp. (°F)	Boiler (Inches)	System (Inches)
B26	26	30 Psig	190	1"	1-1/2"
B48	48	60 Psig	190	1-1/4"	1-1/2"
B72	72	115 Psig	190	1-1/2"	2"
B119	119	115 Psig	190	2"	2"

Standard Equipment: Steel Tank (AS36 Grade), Jacket (22 gauge), Insulation (Fiberglass & Astrofoil - R15), Adjustable Feet for Leveling / Clearances, Temperature / Pressure Gauge, and Drain Valve; ^ NO COPPER COILS.

^ If you are looking for the H2Omax Heat Exchanger (Indirect Water Heater), please go to page 55 for pricing.

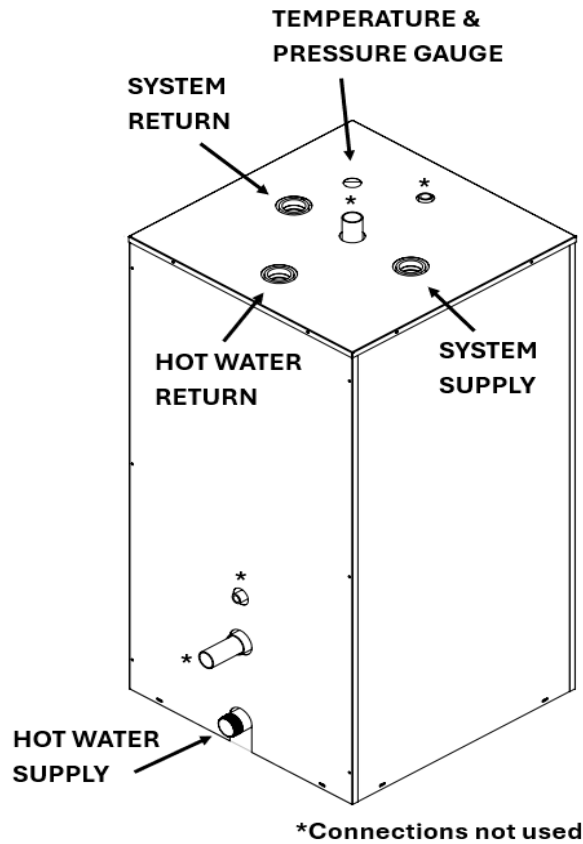

CHEMICAL FEED SYSTEMS

CHEMICAL FEED SYSTEM

A&F MACHINE CHEMICAL FEED SYSTEMS

Simplex Pump Package

Model Sizes	Tank Capacity (Gallons)	Simplex Pump (HP)	Agitator (HP)	Height (Inches)	Diameter (Inches)	Simplex Pump Pkg		Shipping Weight (lbs)
						Part Number		
1560-12-103-612-MP1-OMR	30	1/3	1/4	49"	18"	TBD		294
1560-12-305-612-MP1-OMR	50	1/3	1/4	60"	22"	TBD		315
1560-12-310-612-MP1-OMR	100	1/3	1/4	70"	28"	TBD		333

Duplex Pump Package

Model Sizes	Tank Capacity (Gallons)	Duplex Pump (HP)	Agitator (HP)	Height (Inches)	Diameter (Inches)	Duplex Pump Pkg		Shipping Weight (lbs)
						Part Number		
2560-12-103-612-MP1-OMR	30	1/3	1/4	49"	18"	TBD		304
2560-12-305-612-MP1-OMR	50	1/3	1/4	60"	22"	TBD		325
2560-12-310-612-MP1-OMR	100	1/3	1/4	70"	28"	TBD		343

Equipment Included in Above System:

- Polyethylene Tank with Lid
- V-10 simplex Piston Pump, 1/3HP, TEFC, 120-230V/1PH (Duplex Pump is (2) Heads and (1) Drive)
 - 5/8" Piston Pump, 1000 PSIG Rating, 60 Full Stroke Rate = 360 ML/MIN (Milliters Per Minute), 6 GPH, 144 GPD (Gallons Per Dose)
- Agitator, Direct Drive, Angle Mount, 4" Prop, 1/4 HP, TENV, 120v/1ph
- NEMA 12 Panel:
 - 14 X 12 X 6 NEMA 12 Enclosure
 - Mixer On-Off Switch
 - Pump Hand-Off-Auto (H-O-A) Switch
 - Power Relays for Motors
 - Fuse & Terminals & Lights
 - *Omron Timer (for Water Meter)

*Add Water Meter below as a separate adder to complete this package.

Options are available. Please Consult Factory.

Cold Water Meters

Model Sizes	Size (Inches)	Inlet / Outlet (NPT)	Max Flow (GPM)	** Gallons Contact	Max Temp (°F)	Cold Water Meters		Shipping Weight (lbs)
						Part Number		
EC-621	5/8"	3/4"	20	10	105°F	TBD		8
EC-075	3/4"	3/4"	30	50	105°F	TBD		9
EC-100	1"	1"	50	100	105°F	TBD		18
EC-150	1-1/2"	1-1/2"	100	100	105°F	TBD		25
EC-200	2"	2"	160	100	105°F	TBD		38

** Gallons Per Contact (GPC) is how many gallons of water pass through a flow meter before it sends a single electronic pulse (or contact closure) to a controller.

For Example, the EC-621 Cold Water Meter will send a signal to the chemical feed system to treat the water after 10 gallons of cold water has passed through the system.

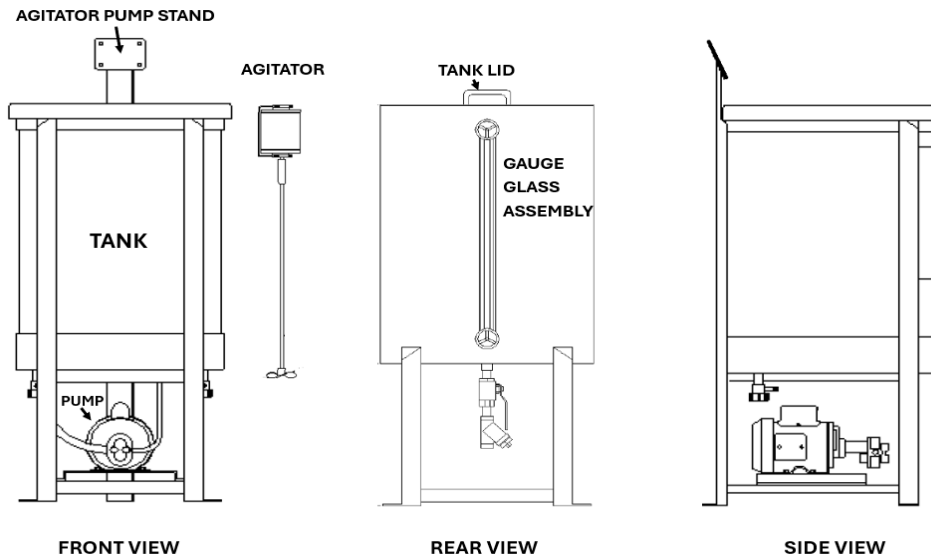

CHEMICAL FEED SYSTEMS

CHEMICAL FEED SYSTEM

A&F MACHINE CHEMICAL SHOT/POT FEEDERS

Shot Feeder (125 PSI)		Shot Feeder (300 PSI)		Bypass Shot Feeder (125 PSI)	
Model Sizes	Part Number	Model Sizes	Part Number	Model Sizes	Part Number
SF-3/4	TBD	SF-3/4-HP	TBD	BPF-3/4	TBD
SF-1	TBD	SF-1-HP	TBD	BPF-1	TBD
SF-1-1/2	TBD	SF-1-1/2-HP	TBD	BPF-1-1/2	TBD
SF-2	TBD	SF-2-HP	TBD	BPF-2	TBD
SF-2-1/2	TBD	SF-2-1/2-HP	TBD	BPF-2-1/2	TBD
SF-5	TBD	SF-5-HP	TBD	BPF-5	TBD
SF-10	TBD	SF-10-HP	TBD	BPF-10	TBD

Shot Feeder (125 PSI); Body Only	
Model Sizes	Part Number
SF-3/4-BO	TBD
SF-1-BO	TBD
SF-1-1/2-BO	TBD
SF-2-BO	TBD
SF-2-1/2-BO	TBD
SF-5-BO	TBD
SF-10-BO	TBD

Options

Miscellaneous	
Description	Part Number
Poly Funnel	TBD
*Add 3 Legs to Smaller Feeders	TBD
* 5 and 10 gallon feeders have 12" legs.	

MODEL NOMENCLATURE:

MODELS

SF Shot Feeder - 150°F
 BPF Bypass Feeder - 150°F

GALLONS

TRIM

Blank 125 PSI Valving
 HP 300 PSI Valving
 BO Feeder Body Only

SF - 2 - HP

DIMENSIONS:

GALLONS	A	B
1	6"	10"
1-1/2	6"	12"
2	8"	10"
2-1/2	8"	12"
5	10"	15"
10	10"	29"
18	14"	32"
25	18"	28"

3/4 GALLON

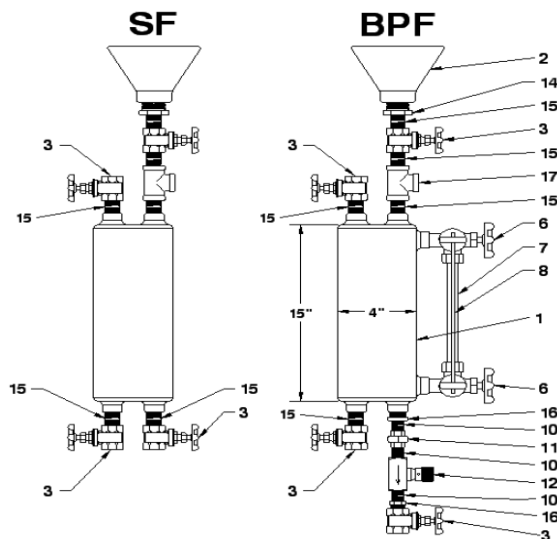

1 GALLON & LARGER

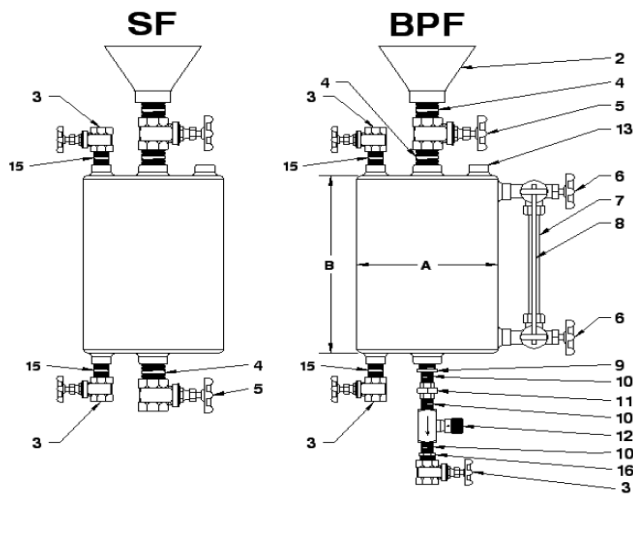

CHEMICAL FEED SYSTEMS

CHEMICAL FEED SYSTEM

A&F MACHINE CHEMICAL SHOT/POT FEEDERS (Continued)

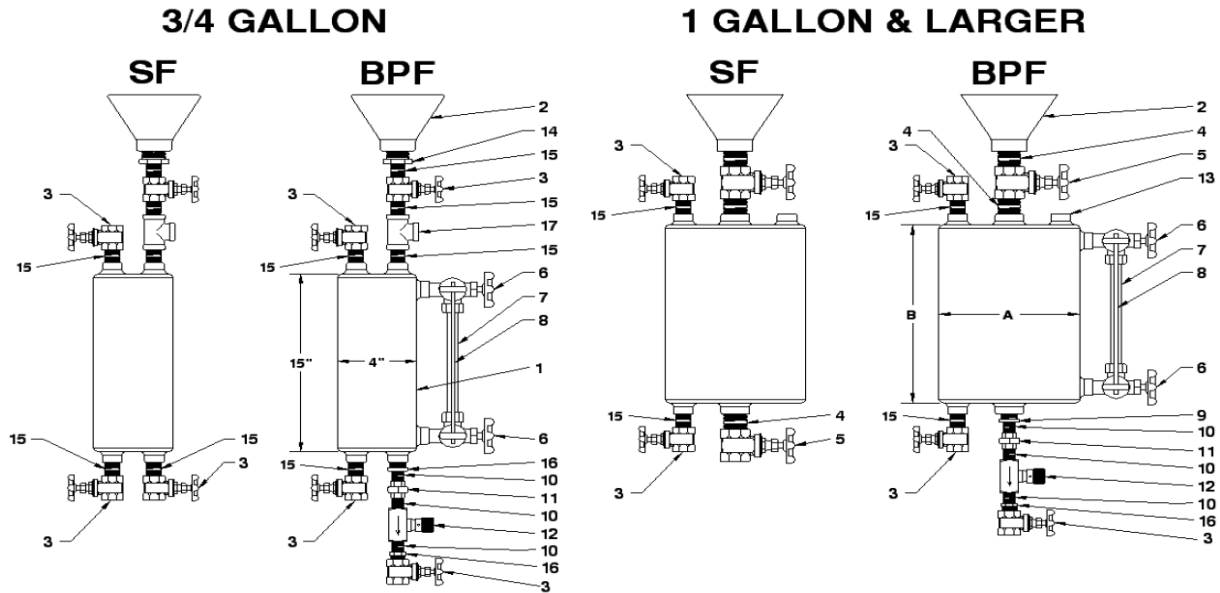

DESCRIPTIONS:

#	DESCRIPTION
1	Feeder Body
2	Poly Funnel
3	1/2" NPT Gate Valve
4	1" NPT Nipple
5	1" NPT Gate Valve
6	1/2" NPT Gauge Glass
7	Gauge Glass
8	Glass Guards
9	1" NPT x 3/8" NPT Bushing
10	3/8" NPT Nipple
11	3/8" NPT Union
12	3/8" NPT Needle Valve
13	1/2" NPT Connection
14	1" NPT x 1/2" NPT Bushing
15	1/2" NPT Nipple
16	1/2" NPT x 3/8" NPT Bushing
17	1/2" NPT Tee

Notes:

- 1) 125 PSI Shot Feeder includes:
 - (1) Feeder body, (2) 1" Gate valves, (1) Poly funnel, (2) 1/2" Gate valves, (3) 1" Nipples, (1) 1/2" Nipples
- 2) 125 PSI By-Pass Feeder includes:
 - (1) Feeder body, (1) 1" Gate valve, (3) 1/2" Gate valves, (1) Gauge glass assembly, (1) Poly funnel, (2) 1" Nipples, (3) 3/8" Nipples, (1) 1" x 3/8" Bushing, (1) 3/8" Union, (1) 3/8" Needle Valve, (2) 1/2" Nipples, (1) 1/2" x 3/8" Bushing
- 3) 300 PSI Shot Feeder includes:
 - (1) Feeder Body, (2) 1/2" Ball valves, (2) 1/2" Nipples, (2) 1" Ball (3) 1" Nipples, (1) Poly funnel

EXPANSION TANKS

HYDRONIC EXPANSION

GRUNDFOS HYDRONIC EXPANSION TANKS - FIXED DIAPHRAGM / PARTIAL ACCEPTANCE, GAX MODELS

Vertical Models - No Anchor Clips

Model Sizes	Capacity (Gallons)	Partial Acceptance (Gallons)	Height (Inches)	Diameter (Inches)	System Connection (Inches)	125 PSIG - No Clips Part Number	Shipping Weight (lbs)
GAX-15V-DD	8.6	3.2	22	12	3/4	TBD	38
GAX-20V-DD	16.5	11.3	25	15	3/4	TBD	51
GAX-40V-DD	23.0	11.3	33	15	3/4	TBD	72
GAX-60V	33.6	11.3	45	16	1/2	TBD	99
GAX-80V	44.4	22.6	29	24	1	TBD	166
GAX-100V	55.7	22.6	34	24	1	TBD	178
GAX-120V	68.0	34.0	47	24	1	TBD	220
GAX-144V	77.0	34.0	52	24	1	TBD	232
GAX-180V	90.0	34.0	60	24	1	TBD	241
GAX-200V	110.0	34.0	66	24	1	TBD	269
GAX-240V	132.0	46.0	58	30	1	TBD	432
GAX-260V	159.0	56.0	65	30	1	TBD	475
GAX-280V	211.0	84.0	82	30	1	TBD	599

Factory Pre-charge: 12 PSIG

Vertical Models - With Anchor Clips

Model Sizes	Capacity (Gallons)	Partial Acceptance (Gallons)	Height (Inches)	Diameter (Inches)	System Connection (Inches)	125 PSIG - With Clips Part Number	Shipping Weight (lbs)
GAX-15V-DD	8.6	3.2	22	12	3/4	TBD	38
GAX-20V-DD	16.5	11.3	25	15	3/4	TBD	51
GAX-40V-DD	23.0	11.3	33	15	3/4	TBD	72
GAX-60V	33.6	11.3	45	16	1/2	TBD	99
GAX-80V	44.4	22.6	29	24	1	TBD	166
GAX-100V	55.7	22.6	34	24	1	TBD	178
GAX-120V	68.0	34.0	47	24	1	TBD	220
GAX-144V	77.0	34.0	52	24	1	TBD	232
GAX-180V	90.0	34.0	60	24	1	TBD	241
GAX-200V	110.0	34.0	66	24	1	TBD	269
GAX-240V	132.0	46.0	58	30	1	TBD	432
GAX-260V	159.0	56.0	65	30	1	TBD	475
GAX-280V	211.0	84.0	82	30	1	TBD	599

Factory Pre-charge: 12 PSIG

GAX-15V-DD - GAX-40V-DD

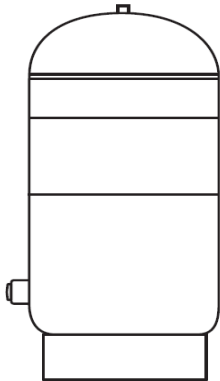

GAX-60V - GAX-100V and GAX-240V & GAX-280V

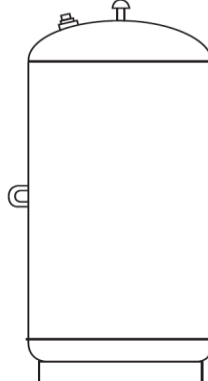

GAX-120V - GAX-240V

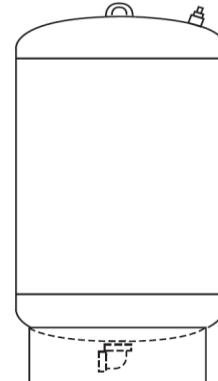

Optional Anchor Clips Shown Below For All Models (As an Example)



- Notes:
- 1) Shell & Heads: Carbon Steel; Max Temp: 240° F.
 - 2) Exterior: Primer & Black Paint Finish.
 - 3) Maximum Working Pressure: 125 PSIG.

EXPANSION TANKS

HYDRONIC EXPANSION

GRUNDFOS HYDRONIC EXPANSION TANKS - FIXED DIAPHRAGM / PARTIAL ACCEPTANCE, GAX MODELS

Inline / Horizontal Models - No Anchor Clips

Model Sizes	Capacity (Gallons)	Partial Acceptance (Gallons)	Height (Inches)	Diameter (Inches)	System Connection (Inches)	125 PSIG - No Clips		Shipping Weight (lbs)
						Part Number		
GAX-10-DD Top	6.4	3.2	22	12	3/4	TBD		9
GAX-15-DD Horz.	8.6	3.2	12	12	3/4	TBD		22
GAX-20-DD Horz.	16.5	11.3	25	15	3/4	TBD		44
GAX-40-DD Horz.	23.0	11.3	33	15	3/4	TBD		64
GAX-60 Horz.	33.6	11.3	45	16	1/2	TBD		96
GAX-80 Horz.	44.4	22.6	29	24	1	TBD		153
GAX-100 Horz.	55.7	22.6	34	24	1	TBD		174
GAX-120 Horz.	68.0	34.0	47	24	1	TBD		204
GAX-144 Horz.	77.0	34.0	52	24	1	TBD		218
GAX-180 Horz.	90.0	34.0	60	24	1	TBD		232
GAX-200 Horz.	110.0	34.0	66	24	1	TBD		269
GAX-240 Horz.	132.0	46.0	58	30	1	TBD		401
GAX-260 Horz.	159.0	56.0	65	30	1	TBD		455
GAX-280 Horz.	211.0	84.0	82	30	1	TBD		580

Factory Pre-charge: 12 PSIG

Inline / Horizontal Models - With Anchor Clips

Model Sizes	Capacity (Gallons)	Partial Acceptance (Gallons)	Height (Inches)	Diameter (Inches)	System Connection (Inches)	125 PSIG - With Clips		Shipping Weight (lbs)
						Part Number		
GAX-10-DD Top	6.4	3.2	22	12	3/4	TBD		9
GAX-15-DD Horz.	8.6	3.2	12	12	3/4	TBD		22
GAX-20-DD Horz.	16.5	11.3	25	15	3/4	TBD		44
GAX-40-DD Horz.	23.0	11.3	33	15	3/4	TBD		64
GAX-60 Horz.	33.6	11.3	45	16	1/2	TBD		96
GAX-80 Horz.	44.4	22.6	29	24	1	TBD		153
GAX-100 Horz.	55.7	22.6	34	24	1	TBD		174
GAX-120 Horz.	68.0	34.0	47	24	1	TBD		204
GAX-144 Horz.	77.0	34.0	52	24	1	TBD		218
GAX-180 Horz.	90.0	34.0	60	24	1	TBD		232
GAX-200 Horz.	110.0	34.0	66	24	1	TBD		269
GAX-240 Horz.	132.0	46.0	58	30	1	TBD		401
GAX-260 Horz.	159.0	56.0	65	30	1	TBD		455
GAX-280 Horz.	211.0	84.0	82	30	1	TBD		580

Factory Pre-charge: 12 PSIG

GAX-10V-DD Top

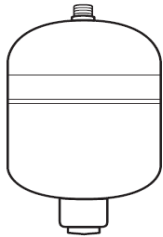

GAX-15-DD - GAX-40-DD Horz.



GAX-60V - GAX-280V



Optional Anchor Clips Shown Below For All Models (As Exmample)

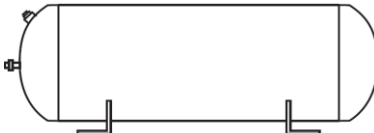

- Notes:
- 1) Shell & Heads: Carbon Steel; Max Temp: 240° F.
 - 2) Exterior: Primer & Black Paint Finish.
 - 3) Maximum Working Pressure: 125 PSIG.

EXPANSION TANKS

HYDRONIC EXPANSION

GRUNDFOS HYDRONIC EXPANSION TANKS - BLADDER TYPE / PARTIAL ACCEPTANCE, GLBC MODELS

125 PSIG

Model Sizes	Capacity (Gallons)	Partial Acceptance (Gallons)	Height (Inches)	Diameter (Inches)	System Connection (Inches)	125 PSI		Shipping Weight (lbs)
						Part Number		
GLBC-35	10	10	37	10	1	TBD		67
GLBC-50	13	11	37	12	1	TBD		76
GLBC-85	22	11	35	16	1	TBD		92
GLBC-100	26	11	39	16	1	TBD		99
GLBC-130	34	27	35	20	1	TBD		135
GLBC-165	44	27	40	20	1	TBD		149

Factory Pre-charge: 12 PSIG

150 PSIG

Model Sizes	Capacity (Gallons)	Partial Acceptance (Gallons)	Height (Inches)	Diameter (Inches)	System Connection (Inches)	150 PSI		Shipping Weight (lbs)
						Part Number		
GLBC-35	10	10	37	10	1	TBD		76
GLBC-50	13	11	37	12	1	TBD		78
GLBC-85	22	11	35	16	1	TBD		95
GLBC-100	26	11	39	16	1	TBD		102
GLBC-130	34	27	35	20	1	TBD		140
GLBC-165	44	27	40	20	1	TBD		153

Factory Pre-charge: 12 PSIG

250 PSIG

Model Sizes	Capacity (Gallons)	Partial Acceptance (Gallons)	Height (Inches)	Diameter (Inches)	System Connection (Inches)	250 PSI		Shipping Weight (lbs)
						Part Number		
GLBC-35	10	10	37	10	1	TBD		94
GLBC-50	13	11	37	12	1	TBD		106
GLBC-85	22	11	35	16	1	TBD		129
GLBC-100	26	11	39	16	1	TBD		138
GLBC-130	34	27	35	20	1	TBD		189
GLBC-165	44	27	40	20	1	TBD		214

Factory Pre-charge: 12 PSIG

With Anchor Clips (Adder)

Model Sizes	Capacity (Gallons)	Partial Acceptance (Gallons)	Height (Inches)	Diameter (Inches)	System Connection (Inches)	* Anchor Clips Adder	
						Part Number	
GLBC-35	10	10	37	10	1	TBD	
GLBC-50	13	11	37	12	1	TBD	
GLBC-85	22	11	35	16	1	TBD	
GLBC-100	26	11	39	16	1	TBD	
GLBC-130	34	27	35	20	1	TBD	
GLBC-165	44	27	40	20	1	TBD	

Factory Pre-charge: 12 PSIG

*Anchor Clips available for All ASME Models: 125, 150 and 250 PSIG.

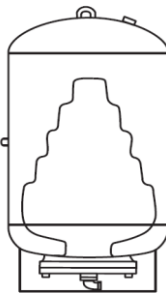

- 3) Maximum Working Pressure: 125 PSIG.
- 4) Heavy Duty Butyl Bladder is Replaceable
- 5) Suitable in Propylene Glycol Applications with Mixtures up to 50%.

EXPANSION TANKS

HYDRONIC EXPANSION

GRUNDFOS HYDRONIC EXPANSION TANKS - BLADDER TYPE / FULL ACCEPTANCE, GL MODELS

125 PSIG

Model Sizes	Full Acceptance (Gallons)	Height (Inches)	Diameter (Inches)	System Connection (Inches)	125 PSI		Shipping Weight (lbs)
					Part Number		
GL-200	53	38	24	1	TBD		190
GL-300	80	52	24	1	TBD		230
GL-400	106	66	24	1	TBD		275
GL-500	132	79	24	1	TBD		311
GL-600	158	64	30	1 1/2	TBD		439
GL-800	211	82	30	1 1/2	TBD		543
GL-1000	264	74	36	1 1/2	TBD		609
GL-1200	317	86	36	1 1/2	TBD		700
GL-1400	370	98	36	1 1/2	TBD		783
GL-1600	422	69	48	1 1/2	TBD		1,106
GL-2000	528	84	48	1 1/2	TBD		1,284
GL-2500	660	101	48	2	TBD		1,544
GL-3000	792	118	48	2	TBD		1,719
GL-3500	925	111	54	2	TBD		2,187
GL-4000	1,057	125	54	2	TBD		2,352
GL-5000	1,321	128	60	2	TBD		2,450
GL-7500	1,980	127	72	3	TBD		4,000
GL-10000	2,640	159	72	3	TBD		4,900
GL-15000	3,963	233	72	3	TBD		6,000

Factory Pre-charge: 12 PSIG

150 PSIG

Model Sizes	Full Acceptance (Gallons)	Height (Inches)	Diameter (Inches)	System Connection (Inches)	150 PSI		Shipping Weight (lbs)
					Part Number		
GL-200	53	38	24	1	TBD		205
GL-300	80	52	24	1	TBD		292
GL-400	106	66	24	1	TBD		343
GL-500	132	79	24	1	TBD		372
GL-600	158	64	30	1 1/2	TBD		510
GL-800	211	82	30	1 1/2	TBD		565
GL-1000	264	74	36	1 1/2	TBD		750
GL-1200	317	86	36	1 1/2	TBD		860
GL-1400	370	98	36	1 1/2	TBD		970
GL-1600	422	69	48	1 1/2	TBD		1,425
GL-2000	528	84	48	1 1/2	TBD		1,675
GL-2500	660	101	48	2	TBD		1,945
GL-3000	792	118	48	2	TBD		2,225
GL-3500	925	111	54	2	TBD		2,375
GL-4000	1,057	125	54	2	TBD		2,640
GL-5000	1,321	128	60	2	TBD		3,740
GL-7500	1,980	127	72	3	TBD		4,300
GL-10000	2,640	159	72	3	TBD		5,300
GL-15000	3,963	233	72	3	TBD		7,600

Factory Pre-charge: 12 PSIG



- 3) Maximum Working Pressure: 125 PSIG.
- 4) Heavy Duty Butyl Bladder is Replaceable
- 5) Suitable in Propylene Glycol Applications with Mixtures up to 50%.

EXPANSION TANKS

HYDRONIC EXPANSION

GRUNDFOS HYDRONIC EXPANSION TANKS - BLADDER TYPE / FULL ACCEPTANCE, GL MODELS

250 PSIG

Model Sizes	Full Acceptance (Gallons)	Height (Inches)	Diameter (Inches)	System Connection (Inches)	250 PSI		* Anchor Clips Adder		Shipping Weight (lbs)
					Part Number		Part Number		
GL-200	53	38	24	1	TBD		TBD		290
GL-300	80	52	24	1	TBD		TBD		385
GL-400	106	66	24	1	TBD		TBD		465
GL-500	132	79	24	1	TBD		TBD		545
GL-600	158	64	30	1 1/2	TBD		TBD		720
GL-800	211	82	30	1 1/2	TBD		TBD		905
GL-1000	264	74	36	1 1/2	TBD		TBD		1,015
GL-1200	317	86	36	1 1/2	TBD		TBD		1,175
GL-1400	370	98	36	1 1/2	TBD		TBD		1,335
GL-1600	422	69	48	1 1/2	TBD		TBD		1,916
GL-2000	528	84	48	1 1/2	TBD		TBD		2,410
GL-2500	660	101	48	2	TBD		TBD		2,585
GL-3000	792	118	48	2	TBD		TBD		2,950
GL-3500	925	111	54	2	TBD		TBD		3,660
GL-4000	1,057	125	54	2	TBD		TBD		4,080
GL-5000	1,321	128	60	2	TBD		TBD		4,200
GL-7500	1,980	127	72	3	TBD		TBD		5,550
GL-10000	2,640	159	72	3	TBD		TBD		6,800
GL-15000	3,963	233	72	3	TBD		TBD		9,800

Factory Pre-charge: 12 PSIG

*Anchor Clips available for All ASME Models: 125, 150 and 250 PSIG.



- Notes:
- 1) Shell & Heads: Carbon Steel; Max Temp: 240° F.
 - 2) Exterior: Primer & Black Paint Finish.
 - 3) Maximum Working Pressure: 125 PSIG.
 - 4) Heavy Duty Butyl Bladder is Replaceable
 - 5) Suitable in Propylene Glycol Applications with Mixtures up to 50%.

EXPANSION TANKS

HYDRONIC EXPANSION

THERMAL SOLUTIONS EXPANSION TANKS - BLADDER TYPE / FULL ACCEPTANCE, TSET MODELS

Model Sizes	Full Acceptance (Gallons)	Height (Inches)	Diameter (Inches)	System Connection (Inches)	Bare Tank 125 PSIG	[5] Top Coat Adder	[1] Shipping Weight (lbs)
					Part Number	Part Number	
TSHET-11	11	24	12	3/4"	TBD	N/A	375
TSHET-15	15	24	14	3/4"	TBD	N/A	425
TSHET-25	25	30	16	3/4"	TBD	N/A	633
TSHET-39	39	49	16	3/4"	TBD	N/A	715
TSHET-58	58	45	20	3/4"	TBD	N/A	1,250
TSHET-85	85	48	24	3/4"	TBD	N/A	1,275
TSHET-104	104	54	24	3/4"	TBD	N/A	1,300
TSHET-147	147	52	30	3/4"	TBD	N/A	1,425
TSHET-158	158	54	30	3/4"	TBD	N/A	1,150
TSHET-175	175	45	67	1-1/2"	TBD	TBD	1,425
TSHET-210	210	53	79	1-1/2"	TBD	TBD	1,885
TSHET-240	240	60	89	1-1/2"	TBD	TBD	1,957
TSHET-285	285	60	36	1-1/2"	TBD	TBD	1,630
TSHET-310	310	66	36	1-1/2"	TBD	TBD	2,800
TSHET-340	340	72	36	1-1/2"	TBD	TBD	3,100
TSHET-360	360	75	36	1-1/2"	TBD	TBD	2,280
TSHET-435	435	80	42	1-1/2"	TBD	TBD	3,375
TSHET-453	453	83	42	1-1/2"	TBD	TBD	4,225
TSHET-505	505	91	42	1-1/2"	TBD	TBD	1,630
TSHET-500	500	83	48	1-1/2"	TBD	TBD	2,800
TSHET-675	675	107	48	1-1/2"	TBD	TBD	3,100
TSHET-765	765	120	48	1-1/2"	TBD	TBD	2,280
TSHET-860	860	132	48	1-1/2"	TBD	TBD	3,375
TSHET-1000	1,000	154	48	1-1/2"	TBD	TBD	4,225

Factory Pre-charge: 12 PSIG

- 1) Top Coat Option will add to the overall shipping weight of tank.
- 2) For Other Custom Options, Please Consult Factory for Details.

11 to 158 Gallon Tanks

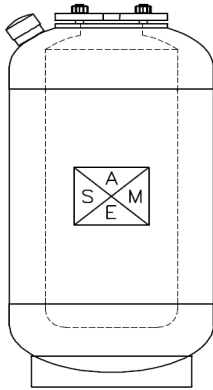

175 Gallon and Larger Tanks

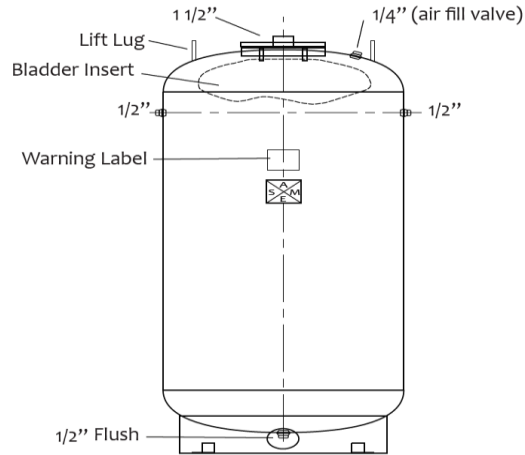

- Notes:
- 1) Shell & Heads: Carbon Steel - Max Temp: 240° F.
 - 2) Exterior: Carbon Steel - Red Oxide Primer.
 - 3) Maximum Working Pressure: Carbon Steel - 125 PSIG.
 - 4) Air Fill Connection, Bottom Drain Connection and Lifting Lugs. Larger Sizes (175 Gallon +) have 1/2" Pressure Gauge Connections.
 - 5) Top Coat is a Sprayed-On Rigid Insulation with Acrylic Top Coating that Exceeds ASHREE 90.1 Requirements with 2.25" of High-Density Polyurethane Foam with an "R" Value of R-16. SPF Meets Requirements for California Title 24. **The Top Coat can be used for Outdoor Use, too.**
 - 6) Heavy Duty Butyl Bladder is Replaceable

EXPANSION TANKS

THERMAL EXPANSION (DHW - NSF 61 AND FDA APPROVED)

GRUNDFOS THERMAL EXPANSION TANKS - FIXED DIAPHRAGM / PARTIAL ACCEPTANCE, GST-DD & VC MODELS

Model Sizes	Capacity (Gallons)	Partial Acceptance (Gallons)	Height (Inches)	Diameter (Inches)	System Connection (Inches)	150 PSIG		Shipping Weight (lbs)
						Part Number		
GST-5C DD	2.0	0.9	14	8	3/4	TBD		10
GST-12C DD	6.4	3.2	18	12	3/4	TBD		26
GST-20VC DD	8.6	3.2	22	12	3/4	TBD		36
GST-30VC DD	16.5	11.2	25	15	3/4	113597-01		48
GST-42VC DD	23.0	11.3	33	15	3/4	TBD		68
GST-60VC	25.0	11.0	32	16	3/4	TBD		85
GST-70VC	34.0	10.9	45	16	3/4	TBD		99
GST-80VC	53.0	35.0	37	24	3/4	TBD		224
GST-120VC	68.0	34.7	44	24	1 1/4	TBD		266
GST-180VC	77.0	34.7	49	24	1 1/4	TBD		285
GST-210VC	90.0	35.1	57	24	1 1/4	TBD		319

Factory Pre-charge: 55 PSIG

GST-5C DD & GST-12C DD

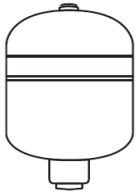

GST-20VC DD - GST-42VC DD

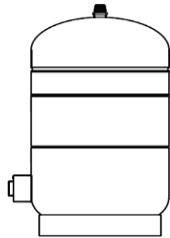

GST-60VC & GST-70VC



GST-80VC - GST-210VC

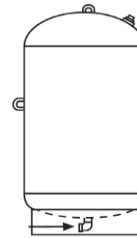

- Notes:
- 1) Shell & Heads: Carbon Steel; Max Temp: 200° F.
 - 2) Exterior: Primer & Black Paint Finish.
 - 3) Maximum Working Pressure: 150 PSIG.
 - 4) Heavy Duty Butyl Diaphragm.
 - 5) Antimicrobial Polypropylene w/Anti-Legionella Protective Liner.

EXPANSION TANKS

THERMAL EXPANSION (DHW - NSF 61 AND FDA APPROVED)

GRUNDFOS THERMAL EXPANSION TANKS - BLADDER TYPE / PARTIAL ACCEPTANCE, GST-CL MODELS

Model Sizes	Capacity (Gallons)	Partial Acceptance (Gallons)	Height (Inches)	Diameter (Inches)	System Connection (Inches)	150 PSIG		Shipping Weight (lbs)
						Part Number		
GST-35-CL	10.0	10.0	37	10	1	TBD		76
GST-50-CL	13.0	11.1	37	12	1	TBD		78
GST-85-CL	22.0	11.0	35	16	1	TBD		95
GST-100-CL	26.0	10.9	39	16	1	TBD		102
GST-130-CL	34.0	26.9	35	20	1	TBD		134
GST-165-CL	44.0	26.8	40	20	1	TBD		153
GST-200-CL	53.0	27.0	41	24	1	TBD		205
GST-300-CL	80.0	27.2	56	24	1	TBD		254
GST-400-CL	106.0	53.0	69	24	1	TBD		308
GST-500-CL	132.0	52.8	83	24	1	TBD		352
GST-600-CL	158.0	53.7	67	30	1	TBD		442

Factory Pre-charge: 25 PSIG

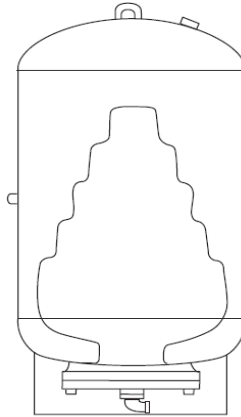

- Notes:
- 1) Shell & Heads: Carbon Steel; Max Temp: 240° F.
 - 2) Exterior: Primer & Black Paint Finish.
 - 3) Maximum Working Pressure: 150 PSIG.
 - 4) Heavy Duty Butyl Bladder is Replaceable.

EXPANSION TANKS

THERMAL EXPANSION (DHW - NSF 61 AND FDA APPROVED)

GRUNDFOS THERMAL EXPANSION TANKS - BLADDER TYPE / FULL ACCEPTANCE, GST-C MODELS

Model Sizes	Full Acceptance (Gallons)	Height (Inches)	Diameter (Inches)	System Connection (Inches)	150 PSIG		Shipping Weight (lbs)
					Part Number		
GST-447-C	53.0	45	24	2	TBD		262
GST-448-C	80.0	59	24	2	TBD		340
GST-449-C	106.0	73	24	2	TBD		360
GST-450-C	132.0	87	24	2	TBD		400
GST-451-C	158.0	73	30	2	TBD		587
GST-452-C	211.0	91	30	2	TBD		625
GST-453-C	264.0	86	36	3	TBD		760
GST-454-C	317.0	98	36	3	TBD		850
GST-455-C	370.0	110	36	3	TBD		935
GST-456-C	422.0	82	48	3	TBD		1,423
GST-457-C	528.0	97	48	3	TBD		1,505

Factory Pre-charge: 25 PSIG

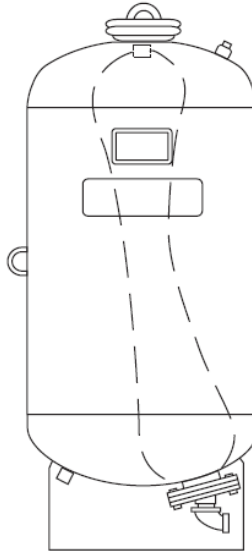

- Notes:
- 1) Shell & Heads: Carbon Steel; Max Temp: 240° F.
 - 2) Exterior: Primer & Black Paint Finish.
 - 3) Maximum Working Pressure: 150 PSIG.
 - 4) Heavy Duty Butyl Bladder is Replaceable.

EXPANSION TANKS

THERMAL EXPANSION (DHW - NSF 61)

THERMAL SOLUTIONS EXPANSION TANKS - BLADDER TYPE / FULL ACCEPTANCE, TSET MODELS

Model Sizes	Full Acceptance (Gallons)	Height (Inches)	Diameter (Inches)	System Connection (Inches)	Bare Tank 125 PSIG		[5] Top Coat Adder		[1]Shipping Weight (lbs)
					Part Number		Part Number		
TSDET-11	11	24	12	3/4"	TBD		N/A		375
TSDET-15	15	24	14	3/4"	TBD		N/A		425
TSDET-25	25	30	16	3/4"	TBD		N/A		633
TSDET-39	39	49	16	3/4"	TBD		N/A		715
TSDET-58	58	45	20	3/4"	TBD		N/A		1,250
TSDET-85	85	48	24	3/4"	TBD		N/A		1,275
TSDET-104	104	54	24	3/4"	TBD		N/A		1,300
TSDET-147	147	52	30	3/4"	TBD		N/A		1,425
TSDET-158	158	54	30	3/4"	TBD		N/A		1,150
TSDET-175	175	45	67	1-1/2"	TBD		TBD		1,425
TSDET-210	210	53	79	1-1/2"	TBD		TBD		1,885
TSDET-240	240	60	89	1-1/2"	TBD		TBD		1,957
TSDET-285	285	60	36	1-1/2"	TBD		TBD		1,630
TSDET-310	310	66	36	1-1/2"	TBD		TBD		2,800
TSDET-340	340	72	36	1-1/2"	TBD		TBD		3,100
TSDET-360	360	75	36	1-1/2"	TBD		TBD		2,280
TSDET-435	435	80	42	1-1/2"	TBD		TBD		3,375
TSDET-453	453	83	42	1-1/2"	TBD		TBD		4,225
TSDET-505	505	91	42	1-1/2"	TBD		TBD		1,630
TSDET-500	500	83	48	1-1/2"	TBD		TBD		2,800
TSDET-675	675	107	48	1-1/2"	TBD		TBD		3,100
TSDET-765	765	120	48	1-1/2"	TBD		TBD		2,280
TSDET-860	860	132	48	1-1/2"	TBD		TBD		3,375
TSDET-1000	1,000	154	48	1-1/2"	TBD		TBD		4,225

Factory Pre-charge: 12 PSIG

- 1) Top Coat Option will add to the overall shipping weight of tank.
- 2) For Other Custom Options, Please Consult Factory for Details.

11 to 158 Gallon Tanks

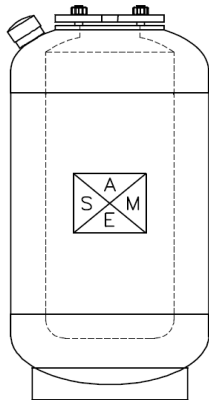

175 Gallon and Larger Tanks

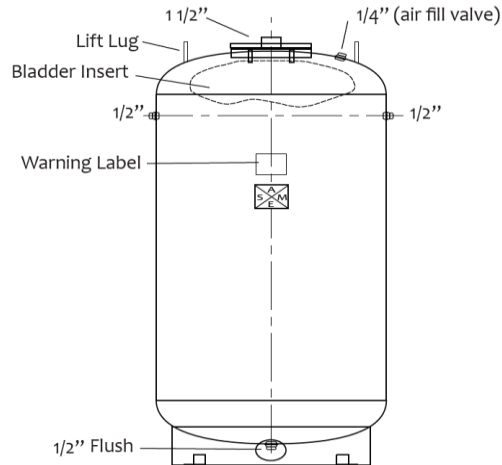

- Notes:
- 1) Shell & Heads: Carbon Steel - Max Temp: 240° F.
 - 2) Exterior: Carbon Steel - Red Oxide Primer.
 - 3) Maximum Working Pressure: Carbon Steel - 150 PSIG.
 - 4) Air Fill Connection, Bottom Drain Connection and Lifting Lugs. Larger Sizes (175 Gallon +) have 1/2" Pressure Gauge Connections.
 - 5) Top Coat is a Sprayed-On Rigid Insulation with Acrylic Top Coating that Exceeds ASHREE 90.1 Requirements with 2.25" of High-Density Polyurethane Foam with an "R" Value of R-16. SPF Meets Requirements for California Title 24. **The Top Coat can be used for Outdoor Use, too.**
 - 6) Heavy Duty Butyl Bladder is Replaceable

EXPANSION TANKS

HYDRO-PNEUMATIC EXPAN. - WELL / BOOSTER PUMP (NSF-61, FDA-APPD)

GRUNDFOS HYDRO-PNEUMATIC EXPN. TANKS - FIXED DIAPHRAGM / PARTIAL ACCEPTANCE, GWX-CDD & C MODELS

Model Sizes	Capacity (Gallons)	Partial Acceptance (Gallons)	Height (Inches)	Diameter (Inches)	System Connection (Inches)	175 PSIG		Shipping Weight (lbs)
						Part Number		
GWX-101C DD	2.0	0.9	14	8	3/4	TBD		10
GWX-102C DD	6.0	3.2	18	12	3/4	TBD		26
GWX-103C DD	9.0	3.2	22	12	3/4	TBD		36
GWX-401C	18.0	11.0	31	16	1	TBD		77
GWX-402C	25.0	11.0	40	16	1	TBD		93
GWX-403C	34.0	11.0	49	16	1	TBD		115
GWX-404C	68.0	34.0	48	24	1 1/4	TBD		227
GWX-405C	90.0	34.0	59	24	1 1/4	TBD		252
GWX-406C	110.0	34.0	70	24	1 1/4	TBD		286
GWX-407C	132.0	46.0	57	30	1 1/4	TBD		436

Factory Pre-charge: 25 PSIG

GWX-101C DD & GWX-102C DD

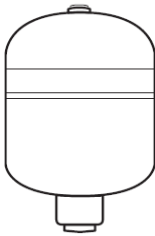

GWX-103C DD

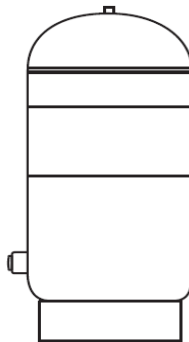

GWX-401C - GWX-407C

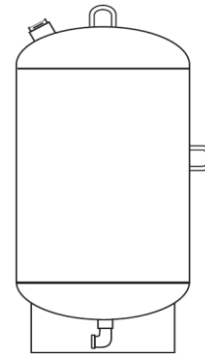

- Notes:
- 1) Shell & Heads: Carbon Steel; Max Temp: 200° F.
 - 2) Exterior: Primer & Black Paint Finish.
 - 3) Maximum Working Pressure: 175 PSIG.
 - 4) Heavy Duty Butyl Diaphragm.
 - 5) Antimicrobial Polypropylene w/Anti-Legionella Protective Liner.

EXPANSION TANKS

HYDRO-PNEUMATIC EXPAN. - WELL / BOOSTER PUMP (NSF-61, FDA-APPD)

GRUNDFOS HYDRO-PNEUMATIC EXPANSION TANKS - BLADDER TYPE / PARTIAL ACCEPTANCE, GWX-CL MODELS

Model Sizes	Capacity (Gallons)	Partial Acceptance (Gallons)	Height (Inches)	Diameter (Inches)	System Connection (Inches)	125 PSIG		Shipping Weight (lbs)
						Part Number		
GWX-35-CL	10.0	10.0	37	10	1 1/4	TBD		69
GWX-50-CL	13.0	11.0	37	12	1 1/4	TBD		76
GWX-85-CL	22.0	11.0	35	16	1 1/4	TBD		92
GWX-100-CL	26.0	11.0	39	16	1 1/4	TBD		98
GWX-130-CL	34.0	27.0	35	20	1 1/2	TBD		136
GWX-165-CL	44.0	27.0	40	20	1 1/2	TBD		146
GWX-200-CL	53.0	27.0	41	24	1 1/2	TBD		198
GWX-300-CL	80.0	27.0	56	24	1 1/2	TBD		236
GWX-400-CL	106.0	53.0	69	24	2	TBD		282
GWX-500-CL	132.0	53.0	83	24	2	TBD		316
GWX-600-CL	158.0	53.0	67	30	2	TBD		450

Factory Pre-charge: 25 PSIG

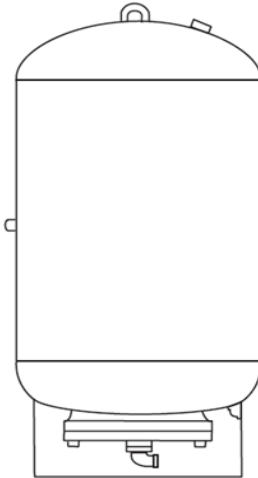

- Notes:
- 1) Shell & Heads: Carbon Steel; Max Temp: 240° F.
 - 2) Exterior: Primer & Black Paint Finish.
 - 3) Maximum Working Pressure: 125 PSIG.
 - 4) Heavy Duty Butyl Bladder is Replaceable.

EXPANSION TANKS

HYDRO-PNEUMATIC EXPAN. - WELL / BOOSTER PUMP (NSF-61, FDA-APPD)

GRUNDFOS HYDRO-PNEUMATIC EXPANSION TANKS - BLADDER TYPE / FULL ACCEPTANCE, GWX-C MODELS

Model Sizes	Full Acceptance (Gallons)	Height (Inches)	Diameter (Inches)	System Connection (Inches)	125 PSIG		Shipping Weight (lbs)
					Part Number		
GWX-447C	53	45	24	2	TBD		263
GWX-448C	80	59	24	2	TBD		315
GWX-449C	106	73	24	2	TBD		319
GWX-450C	132	87	24	2	TBD		351
GWX-451C	158	73	30	2	TBD		493
GWX-452C	211	91	30	2	TBD		602
GWX-453C	264	86	36	3	TBD		676
GWX-454C	317	98	36	3	TBD		762
GWX-455C	370	110	36	3	TBD		843
GWX-456C	422	82	48	3	TBD		1,154
GWX-457C	528	97	48	3	TBD		1,331
GWX-458C	660	84	60	4	TBD		1,450
GWX-459C	792	99	60	4	TBD		2,169
GWX-460C	925	107	60	4	TBD		2,300
GWX-461C	1,056	121	60	4	TBD		2,638
GWX-462C	1,320	104	72	4	TBD		3,500
GWX-463C	1,980	140	72	4	TBD		4,100

Factory Pre-charge: 25 PSIG

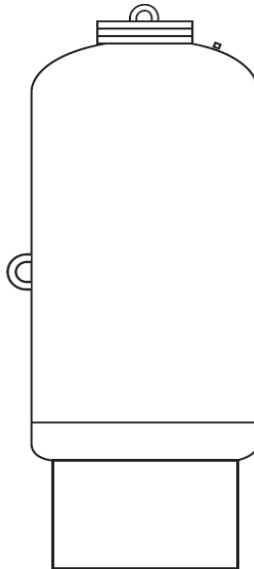

- Notes:
- 1) Shell & Heads: Carbon Steel; Max Temp: 240° F.
 - 2) Exterior: Primer & Black Paint Finish.
 - 3) Maximum Working Pressure: 125 PSIG.
 - 4) Heavy Duty Butyl Bladder is Replaceable.

GAS DETECTION MONITOR

GAS DETECTION MONITOR

AMERICAN GAS SAFETY DUAL GAS DETECTION (CARBON MONOXIDE & COMBUSTIBLE GAS), MINI MERLIN MODEL

Model Sizes	Mini Merlin Model Description	Height (Inches)	Width (Inches)	Depth (Inches)	Part Number	Shipping Weight (oz)
AGSCH4CO	NAT/CO Dual Detector Isolation Panel	5.95	4.37	1.97	TBD	12.2
AGSLPGCO	LPG/CO Dual Detector Isolation Panel	5.95	4.37	1.97	TBD	12.2

The AGS Mini Merlin dual gas detector provides protection over combustible gas leaks and high concentrations of carbon monoxide. An affordable and adaptable solution to carbon monoxide interlocks and emergency gas shut-down. The Mini Merlin provides adaptable outputs to govern the supply of fuel or power to gas fired appliances and pre programmed relays to break limit circuits or signal building management systems or fire alarm. Simple inputs for remote panic buttons or fire alarms make the Mini a convenient wiring center in the mechanical room. Design and listed to UL standards for the purpose of monitoring gas levels, with built in audible and visual alarm signals and a manual re-set button, the Mini Merlin is code compliant straight out of the box.

AC Power: 100-120V~ 50/60Hz

Features:

- Compact Design.
- Commercial Grade Sensors
- Clear Visual Display
- Adaptable Outputs
- Shut off an Appliance
 - Gas Valve
 - Electrical Circuit
- Alarm Condition Held for First Responders
- End of Life Alarm
- Accepts Inputs from
 - Panic Buttons
 - Fire Alarm
 - Smoke Detectors
- Interconnect multiple units



GLYCOL FEED SYSTEMS

GLYCOL FEED SYSTEMS

GRUNDFOS GLYCOL FEED SYSTEMS

Simplex Pump Package - GGMP Models

Model Sizes	Tank Capacity (Gallons)	Make-Up Capacity (GPM @ PSI)	Height (Inches)	Width (Inches)	Depth (Inches)	Part Number		Shipping Weight (lbs)
GGMP-6	6	1.6 @ 60	17.50"	12"	12"	TBD		16
GGMP-18	18	1.6 @ 60	39.25"	12"	12"	TBD		25

Factory Discharge Pressure Setting: 12 PSIG

Electrical: 120 Vac/1 ph/60 Hz with 6 ft cord/ standard plug

Equipment Included in Above Systems:

- Polyethylene Solution Tank
- Bronze Pump
- > Includes a magnetic starter, a pressure control, a priming valve, a shut-off valve and a pressure gauge
- Pump Cut-Off and Visual & Audible Alarm for Excessive Pressure or Low Suction Level
- Steel Base Gray Paint
- Max Pressure: 70 PSIG
- Max Temp: 120°F



Simplex Pump Package - GGMP Models

Model Sizes	Tank Capacity (Gallons)	Simplex Pump (HP)	Make-Up Capacity (GPM @ PSI)	Height (Inches)	Diameter (Inches)	Part Number		Shipping Weight (lbs)
GGMP-13050	50	1/3	1.8 @ 70	42"	34"	TBD		134
GGMP-13100	100	1/3	1.8 @ 70	66"	34"	TBD		140
GGMP-15050	50	1/2	1.8 @ 70	42"	34"	TBD		138
GGMP-15100	100	1/2	1.8 @ 70	66"	34"	TBD		144

Factory Discharge Pressure Setting: 12 PSIG

Electrical: 110 Vac/1 ph/60 Hz

Equipment Included in Above Systems:

- Polyethylene Solution Tank
- Bronze Pump
- > Includes a magnetic starter, a pressure control, a priming valve, a shut-off valve and a pressure gauge
- Pump Cut-Off and Visual & Audible Alarm for Excessive Pressure or Low Suction Level
- Steel Base Gray Paint
- Max Pressure: 70 PSIG
- Max Temp: 120°F

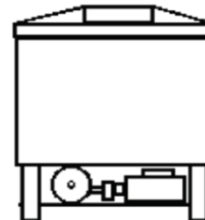

Duplex Pump Package - GGMPD Models

Model Sizes	Tank Capacity (Gallons)	Twin Pumps (HP)	Make-Up Capacity (GPM @ PSI)	Height (Inches)	Diameter (Inches)	Part Number		Shipping Weight (lbs)
GGMPD-23050	50	1/3	1.8 @ 70	52"	34"	TBD		214
GGMPD-23100	100	1/3	1.8 @ 70	76"	34"	TBD		255
GGMPD-25050	50	1/2	1.8 @ 70	52"	34"	TBD		218
GGMPD-25100	100	1/2	1.8 @ 70	76"	34"	TBD		259

Factory Discharge Pressure Setting: 12 PSIG

Electrical: 110 Vac/1 ph/60 Hz

Equipment Included in Above Systems:

- Polyethylene Solution Tank
- (2) Bronze Pumps
- > Includes a magnetic starters, a pressure control, a priming valve, a shut-off valve and a pressure gauge
- Pump Cut-Off and Visual & Audible Alarm for Excessive Pressure or Low Suction Level
- Steel Base Gray Paint
- Max Pressure: 70 PSIG
- Max Temp: 120°F

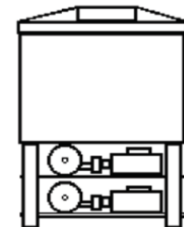

GLYCOL FEED SYSTEMS

GLYCOL FEED SYSTEMS

GRUNDFOS GLYCOL FEED SYSTEMS

Duplex Pumps Package with Alternator - GMPT Models

Model Sizes	Tank Capacity (Gallons)	Simplex Pump (HP)	Make-Up Capacity (GPM @ PSI)	Height (Inches)	Diameter (Inches)	Part Number		Shipping Weight (lbs)
GMPT-33050	50	1/3	1.8 @ 70	52"	43"	TBD		236
GMPT-33100	100	1/3	1.8 @ 70	76"	43"	TBD		226
GMPT-35050	50	1/2	1.8 @ 70	52"	43"	TBD		240
GMPT-35100	100	1/2	1.8 @ 70	76"	43"	TBD		230

Factory Discharge Pressure Setting: 12 PSIG
Electrical: 110 Vac/1 ph/60 Hz

Equipment Included in Above Systems:

- Polyethylene Solution Tank
- (2) Bronze Pumps
- Pump Cut-Off and Visual & Audible Alarm for Excessive Pressure or Low Suction Level
- Alternator (If Primary Pump Fails, Backup Pump is Activated)
- Control Panel with H-O-A Switches
- > Includes a magnetic starters, a pressure control, a priming valve, a shut-off valve and a pressure gauge
- Steel Base Gray Paint
- Max Pressure: 70 PSIG
- Max Temp: 120°F

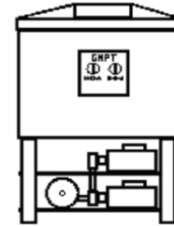

A&F MACHINE GLYCOL FEED SYSTEMS

Simplex Pump Package - AF Models

Model Sizes	Tank Capacity (Gallons)	Simplex Pump (HP)	Make-Up Capacity (GPM @ PSI)	Height (Inches)	Width (Inches)	Depth (Inches)	Simplex Pump Pkg Part Number	Shipping Weight (lbs)
AF-1	50	1/2	3 @ 60	60"	22"	32"	TBD	315
AF-4	100	1/2	3 @ 60	70"	28"	38"	TBD	333

Equipment Included in Above System:

- Polyethylene Tank
- Bronze Gear Pump, 1/2 HP, 120V/1PH MOTOR
- 30-50 PSI Pressure Switch
- 3/4" NPT Brass Line Check Valve
- 3/4" NPT Nylon Pressure Relief Valve
- 0-100 PSI Pressure Gauge
- Glycol Discharge Piping
- NEMA 12 Panel:
 - 14 X 12 X 6 NEMA 12 Enclosure
 - Pump Hand-Off-Auto (H-O-A) Switch
 - Power Relay for Motor
 - Fuse & Terminals & Lights
 - Low Level Alarm & Cutoff Circuit

Options are available. Please Consult Factory.

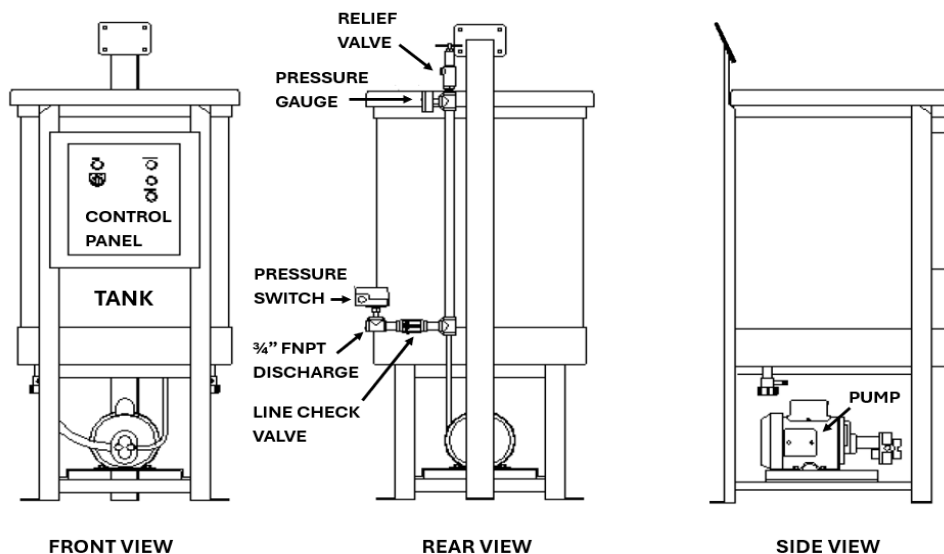

HEAT EXCHANGERS

HEAT EXCHANGERS

GRUNDFOS HEAT EXCHANGERS

Information Needed for Sizing & Quoting (Consult Factory for Pricing)

Heat Load: _____ Btu (Boiler output)

Tube Side (Boiler):

Fluid – Water/ * Steam

Inlet Temperature: _____ °F

Outlet Temperature: _____ °F

Flow Rate: _____ GPM

Tank Side (Storage):

Fluid – Water/ * Steam

Inlet Temperature: _____ °F

Outlet Temperature: _____ °F

Recovery Rate: _____ GPH

*Saturated Steam Temperatures for Reference

Gauge Pressure (Psig)	Temperature (°F)
0	212
1	215
2	219
3	222
4	224
5	227
6	230
7	232
8	233
9	237
10	239
12	244
14	248
16	252
18	256
20	259
22	262
24	265
26	268
28	271
30	274
32	277
34	279
36	282
38	284
40	286
42	289
44	291
46	293
48	295
50	298

Gauge Pressure (Psig)	Temperature (°F)
55	300
60	307
65	312
70	316
75	320
80	324
85	328
90	331
95	335
100	338
105	341
110	344
115	347
120	350
125	353
130	356
135	358
140	361
145	363
150	366
155	368
160	371
165	373
170	375
175	377
180	380
185	382
190	384
195	386
200	388
205	390

MAGNETIC FILTERS

MAGNETIC FILTERS

BOILERMAG MAGNETIC FILTERS, BMXT MODELS

Model Sizes	Pipe Size "A" (NPT)	Magnetic Rods (Qty)	Flow (GPM)	Dimensions (Inches)			NPT Pricing		Shipping Weight (lbs)
				"B"	"C"	"D"	Part Number		
BMXT100	1-1/2"	3	40	4"	10"	11"	TBD		20
BMXT150	2"	5	79	6-3/4"	11"	11"	TBD		42

Model Sizes	Pipe Size "A" (Flanged)	Magnetic Rods (Qty)	Flow (GPM)	Dimensions (Inches)			Flanged Pricing		Shipping Weight (lbs)
				"B"	"C"	"D"	Part Number		
BMXT150/2.5	2-1/2"	5	79	6-3/4"	12-3/8"	11"	TBD		42
BMXT200/3	3"	7	229	8-5/8"	14-1/8"	13-1/4"	109844-02		82
BMXT200	4"	7	308	8-5/8"	14-7/8"	13-1/4"	109844-01		82
BMXT300HF	6"	9	440	12-3/4"	19-1/4"	16-1/2"	TBD		133
BMXT300HF/8	8"	9	950	12-3/4"	20-5/8"	18-1/8"	TBD		140
BMXT400/10	10"	16	968	16"	30"	29-3/4"	TBD		190
BMXT400/12	12"	16	1,364	16"	30"	29-3/4"	TBD		195

Spare O-rings:	Part Number
BMXT100 & 150 Sizes	TBD
BMXT200 Sizes	TBD
BMXT300 Sizes	TBD
BMXT400 Sizes	TBD

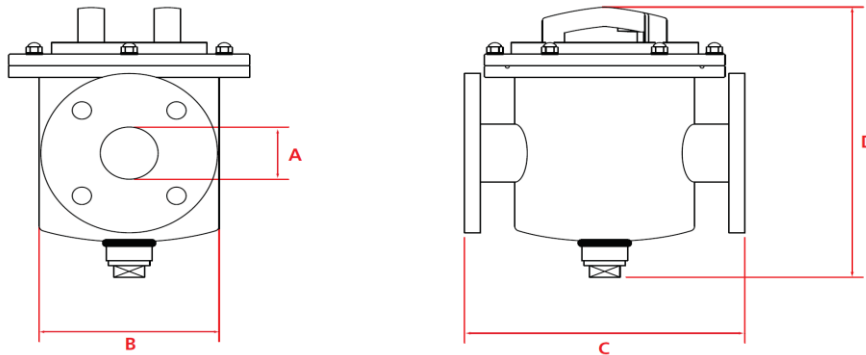

PUMP ACCESSORIES

SUCTION DIFFUSERS

GRUNDFOS SUCTION DIFFUSERS, SD MODELS

125 PSIG ANSI

Model Sizes	Inlet / Outlet Pipe Size (Flanged)	Strainer Open Area (Sq.In.)	Dimensions (Inches)				125 PSIG ANSI Part Number	Shipping Weight (lbs)
			L	L1	H	H2		
SD2015-125	2" x 1-1/2"	35	8 1/5	5	7 1/5	4	TBD	21
SD2020-125	2" x 2"	38	8 3/10	5 1/10	7 1/5	4	TBD	24
SD2520-125	2-1/2" x 2"	38	9 7/10	6	8 3/5	5	TBD	29
SD2525-125	2-1/2" x 2-1/2"	40	9 7/10	6	8 3/5	5	TBD	34
SD3020-125	3" x 2"	38	11 1/10	7 1/10	9 3/5	5 3/5	TBD	39
SD3025-125	3" x 2-1/2"	40	11 1/10	7 1/10	9 3/5	5 3/5	TBD	39
SD3030-125	3" x 3"	50	11 1/10	7 1/10	9 3/5	5 3/5	TBD	40
SD4030-125	4" x 3"	50	12 9/10	8 3/10	11 2/5	6 1/2	TBD	60
SD4040-125	4" x 4"	78	12 9/10	8 3/10	11 2/5	6 1/2	TBD	64
SD5040-125	5" x 4"	78	14 1/10	9 2/5	12 2/5	6 9/10	TBD	91
SD5050-125	5" x 5"	102	13 3/5	9	12 2/5	6 9/10	TBD	93
SD6040-125	6" x 4"	78	15 2/5	10 1/10	13 9/10	8	TBD	120
SD6050-125	6" x 5"	102	15 3/5	10 3/10	13 9/10	8	TBD	122
SD6060-125	6" x 6"	154	15 2/5	10 1/10	13 9/10	8	TBD	137
SD8060-125	8" x 6"	154	18 1/5	11 9/10	17 3/10	10	TBD	188
SD8080-125	8" x 8"	280	18 1/5	11 9/10	17 3/10	10	TBD	201
SD1080-125	10" x 8"	280	23 1/2	14 3/10	20 3/5	11 1/2	TBD	305
SD1010-125	10" x 10"	430	23 1/2	14 3/10	20 3/5	11 1/2	TBD	314
SD1280-125	12" x 8"	280	28	17 9/10	23 1/2	12 9/10	TBD	441
SD1210-125	12" x 10"	430	28	17 9/10	23 1/2	12 9/10	TBD	448
SD1212-125	12" x 12"	560	28	17 9/10	23 1/2	12 9/10	TBD	455

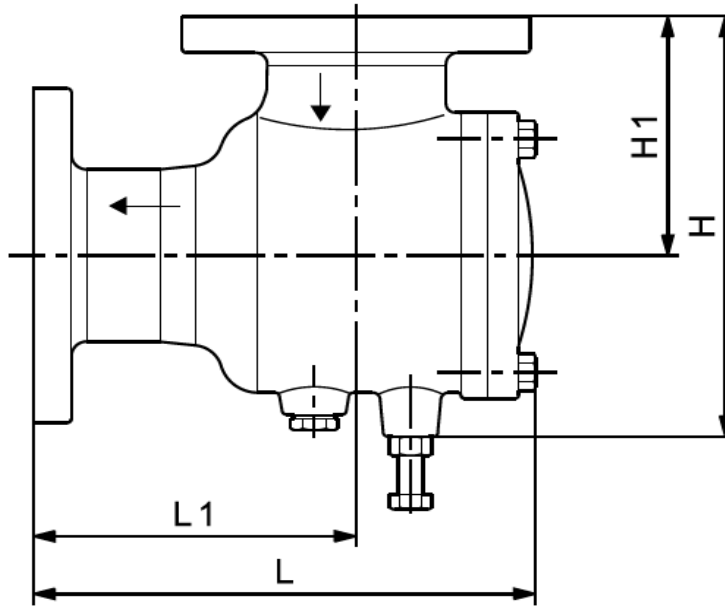

- Notes:
- 1) Maximum Temp: 248° F.
 - 2) Exterior: Primer & Black Paint Finish.
 - 3) Maximum Working Pressure: 175 PSIG.

PUMP ACCESSORIES

SUCTION DIFFUSERS

GRUNDFOS SUCTION DIFFUSERS, SD MODELS

250 PSIG ANSI

Model Sizes	Inlet / Outlet Pipe Size (Flanged)	Strainer Open Area (Sq.In.)	Dimensions (Inches)				125 PSIG ANSI	Shipping Weight (lbs)
			L	L1	H	H2	Part Number	
SD2015-250	2" x 1-1/2"	35	8 2/5	5 1/5	7 2/5	4 1/5	TBD	21
SD2020-250	2" x 2"	38	8 1/2	5 3/10	7 2/5	4 1/5	TBD	24
SD2525-250	2-1/2" x 2-1/2"	40	9 7/10	6	8 3/5	5	TBD	34
SD3020-250	3" x 2"	38	11 1/10	7 1/10	9 3/5	4	TBD	39
SD3025-250	3" x 2-1/2"	40	11 1/10	7 1/10	9 3/5	5 3/5	TBD	39
SD3030-250	3" x 3"	50	11 1/10	7 1/10	9 3/5	5 3/5	TBD	40
SD4030-250	4" x 3"	50	12 9/10	8 3/10	11 2/5	6 1/2	TBD	60
SD4040-250	4" x 4"	78	12 9/10	8 3/10	11 2/5	6 1/2	TBD	64
SD5040-250	5" x 4"	78	14 1/10	9 2/5	12 1/10	6 9/10	TBD	91
SD5050-250	5" x 5"	102	14 1/10	9	12 1/10	6 9/10	TBD	93
SD6040-250	6" x 4"	78	15 2/5	10 1/10	13 9/10	8	TBD	120
SD6050-250	6" x 5"	102	15 3/5	10 3/10	13 9/10	8	TBD	122
SD6060-250	6" x 6"	154	15 2/5	10 1/10	13 9/10	8	TBD	137
SD8060-250	8" x 6"	154	18 3/5	12 3/10	17 4/5	10 1/2	TBD	188
SD8080-250	8" x 8"	280	18 3/5	12 2/5	17 4/5	10 1/2	TBD	201
SD1080-250	10" x 8"	280	23 1/2	14 3/10	20 3/5	11 1/2	TBD	305
SD1010-250	10" x 10"	430	23 1/2	14 3/10	20 3/5	11 1/2	TBD	314
SD1210-250	12" x 10"	430	28	17 9/10	23 1/2	12 9/10	TBD	448
SD1212-250	12" x 12"	560	28	17 9/10	23 1/2	12 9/10	TBD	455

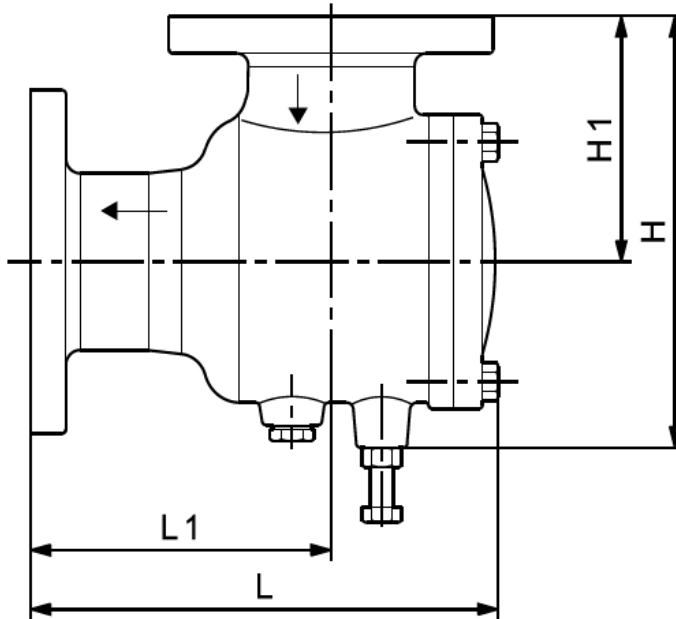

- Notes: 1) Maximum Temp: 248° F.
 2) Exterior: Primer & Black Paint Finish.
 3) Maximum Working Pressure: 250 PSIG.

PUMP ACCESSORIES

COMBINATION VALVES

GRUNDFOS COMBINATION VALVES, CV MODELS

125 PSIG ANSI

Model Sizes	Inlet / Outlet Pipe Size (Flanged)	Dimensions (Inches)		125 PSIG ANSI		Shipping Weight (lbs)
		L	L1	Part Number		
CV20-125	2" x 2"	9 3/8	8	TBD		36
CV25-125	2-1/2" x 2-1/2"	11	8 5/8	TBD		42
CV30-125	3" x 3"	11 2/3	9 3/5	TBD		52
CV40-125	4" x 4"	13 1/4	10 5/6	TBD		102
CV50-125	5" x 5"	14 2/9	11 8/9	113532-01		160
CV60-125	6" x 6"	17 2/7	14 4/9	TBD		205
CV80-125	8" x 8"	20 1/4	16 2/3	TBD		355
CV10-125	10" x 10"	25	21 1/2	TBD		485
CV12-125	12" x 12"	27 4/9	23 1/3	TBD		665
CV14-125	14" x 14"	29 4/5	27 2/3	TBD		795

250 PSIG ANSI

Model Sizes	Inlet / Outlet Pipe Size (Flanged)	Dimensions (Inches)		250 PSIG ANSI		Shipping Weight (lbs)
		L	L1	Part Number		
CV20-250	2" x 2"	9 3/8	8	TBD		36
CV25-250	2-1/2" x 2-1/2"	11	8 5/6	TBD		42
CV30-250	3" x 3"	11 2/3	9 3/5	TBD		52
CV40-250	4" x 4"	13 1/4	10 5/6	TBD		102
CV50-250	5" x 5"	14 1/2	11 8/9	TBD		160
CV60-250	6" x 6"	17 2/7	14 4/9	TBD		205
CV80-250	8" x 8"	20 1/4	16 2/3	TBD		355
CV10-250	10" x 10"	26 3/7	21 1/2	TBD		485
CV12-250	12" x 12"	29	23 1/3	TBD		665
CV14-250	14" x 14"	31 1/3	27 2/3	TBD		795

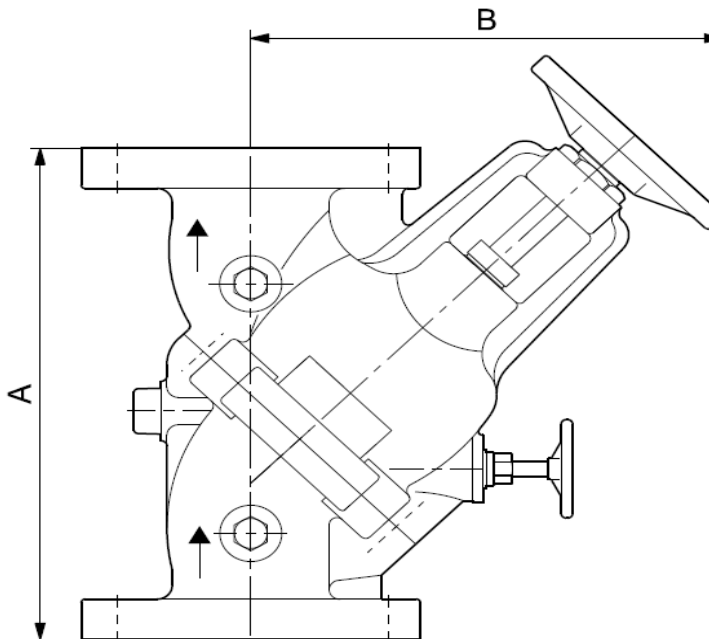

- Notes:
- 1) Maximum Temp: 150° F (125 PSIG ANSI) / 248°F (250 ANSI)
 - 2) Exterior: Primer & Black Paint Finish.
 - 3) Maximum Working Pressure: 175 PSIG (125 PSIG ANSI) / 250 PSIG (250 ANSI)

STORAGE TANKS

STORAGE TANKS - SMALL VOLUME / VERTICAL

THERMAL SOLUTIONS STORAGE TANKS - SMALL VOLUME / VERTICAL, TSV MODELS

Bare Tanks and Top Coat Adder

* Model Sizes	Storage Capacity (Gallons)	OA Height (Inches)	Diameter (Inches)	Replacement Anodes (Qty & Size)	Bare Tank		[5] Top Coat Adder		[1] Shipping Weight (Aprx. lbs)
					Part Number		Part Number		
TSV40-B1	40	45	16	2 - 3/4" x 52"	TBD		TBD		78
TSV50-B1	50	CF	CF	2 - 3/4" x 52"	TBD		TBD		CF
TSV80-B1	80	58	20	2 - 3/4" x 52"	TBD		TBD		157
TSV80-B1-A	80	58	20	2 - 3/4" x 52"	TBD		TBD		157
TSV119-B1	119	62	24	2 - 3/4" x 52"	TBD		TBD		175
TSV119-B1-A	119	62	24	2 - 3/4" x 52"	TBD		TBD		175
TSV200-B1-A	200	79	28	2 - 3/4" x 52"	TBD		TBD		435

Jacketed & Insulated Tanks

* Model Sizes	Storage Capacity (Gallons)	OA Height (Inches)	Diameter (Inches)	Replacement Anodes (Qty & Size)	Jacketed & Insulated		[1] Shipping Weight (lbs)
					Part Number		
TSV40-J1	40	47 7/8	22	2 - 3/4" x 52"	TBD		103
TSV50-J1	50	47 7/16	22	2 - 3/4" x 52"	TBD		130
TSV80-J1	80	59 3/4	24	2 - 3/4" x 52"	TBD		192
TSV80-J1-A	80	59 3/4	24	2 - 3/4" x 52"	TBD		192
TSV119-J1	119	63 1/2	28	2 - 3/4" x 52"	113531-01		225
TSV119-J1-A	119	63 1/2	28	2 - 3/4" x 52"	TBD		225
TSV200-J1-A	200	78	32	2 - 3/4" x 52"	113531-02		541

* Nomenclature:

TS	V	119	-	J	1	
Thermal Solutions	Vertical	Actual Gallons		B = Bare J = Jacketed & Insulated T = Top Coat	1 = 10 Mills Glass Lining	Blank = 150 PSIG Design Non-ASME A = ASME Design

1) Top Coat Option will add to the overall shipping weight of tank.

Replacement Parts

Model Sizes	Part Number	
150 PSI T&P Valve	109898-02	
Diverter Tube	112491-02	
Anode 3/4" x 52"	113140-01	

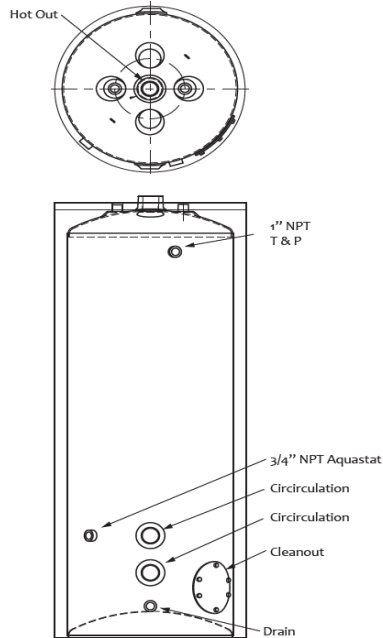

(Image depicts Jacket & Insulation)

- Notes:
- 1) Shell & Heads: Carbon Steel - Max Temp: 240° F.
 - 2) Exterior: Carbon Steel - Red Oxide Primer (Bare) / Baked Enamel 24 Gauge Steel with 2" R-12.5 Open Cell Foam (Jacket & Insulation).
 - 3) Maximum Working Pressure: Carbon Steel - 150 PSIG.
 - 4) Tank Pricing Includes Temperature & Pressure Relief Valve and Diverter Tube (Evenly Distributes Incoming Cold Water throughout the Vessel).
 - 5) Top Coat is a Sprayed-On Rigid Insulation with Acrylic Top Coating that Exceeds ASHREE 90.1 Requirements with 2.25" of High-Density Polyurethane Foam with an "R" Value of R-16. SPF Meets Requirements for California Title 24. **The Top Coat can be used for Outdoor Use, too.**

STORAGE TANKS

STORAGE TANKS - LARGE VOLUME / VERTICAL

THERMAL SOLUTIONS STORAGE TANKS - LARGE VOLUME / VERTICAL, TSV MODELS

Bare and Jacketed & Insulated Tanks

* Model Sizes	Storage Capacity (Gallons)	Bare Dims (+ 4" to H & D for J&I)		Replacement Anodes (Qty & Size)	Bare Tank		J&I Tanks		Shipping Weight	
		OA Height (Inches)	Diameter (Inches)		Part Number		Part Number		Bare (Aprx. lbs)	J&I (Aprx. lbs)
TSV175-*1	175	67"	30"	2 - 1"x28"	TBD		TBD		340	550
TSV210-*1	210	79"	30"	2 - 1"x28"	TBD		113531-03		387	615
TSV240-*1	240	89"	30"	2 - 1"x28"	TBD		TBD		420	675
TSV280-*1	280	103"	30"	3 - 1"x28"	TBD		113531-04		483	700
TSV320-*1	320	115"	30"	3 - 1"x28"	TBD		113531-12		530	730
TSV285-*1	285	76"	36"	2 - 1"x34"	TBD		113531-05		550	715
TSV310-*1	310	82"	36"	2 - 1"x34"	TBD		113531-06		588	785
TSV340-*1	340	89"	36"	2 - 1"x34"	TBD		TBD		633	845
TSV360-*1	360	94"	36"	2 - 1"x34"	TBD		TBD		664	895
TSV415-*1	415	106"	36"	3 - 1"x28"	TBD		113531-10		742	985
TSV465-*1	465	118"	36"	3 - 1"x28"	TBD		TBD		818	1,110
TSV515-*1	515	130"	36"	3 - 1"x34"	TBD		TBD		894	1,195
TSV385-*1	385	76"	42"	2 - 1"x40"	TBD		TBD		720	850
TSV435-*1	435	85"	42"	2 - 1"x40"	TBD		113531-11		783	1,025
TSV450-*1	450	88"	42"	2 - 1"x40"	TBD		TBD		805	1,075
TSV505-*1	505	97"	42"	3 - 1"x28"	TBD		113531-08		874	1,170
TSV575-*1	575	109"	42"	3 - 1"x34"	TBD		TBD		963	1,295
TSV645-*1	645	121"	42"	3 - 1"x34"	TBD		TBD		1,052	1,395
TSV720-*1	720	133"	42"	3 - 1"x40"	TBD		TBD		1,140	1,500
TSV775-*1	775	143"	42"	4 - 1"x34"	TBD		TBD		1,217	1,590
TSV500-*1	500	77"	48"	2 - 1"x40"	TBD		113531-07		1,038	1,385
TSV580-*1	580	88"	48"	2 - 1"x40"	TBD		TBD		1,161	1,540
TSV675-*1	675	100"	48"	3 - 1"x34"	TBD		113531-09		1,298	1,655
TSV765-*1	765	112"	48"	3 - 1"x40"	TBD		TBD		1,433	1,805
TSV836-*1	836	122"	48"	3 - 1"x40"	TBD		TBD		1,522	1,875
TSV860-*1	860	124"	48"	3 - 1"x40"	TBD		TBD		1,567	1,947
TSV1040-*1	1,040	145"	48"	4 - 1"x40"	TBD		TBD		1,805	2,216
TSV1225-*1	1,225	174"	48"	5 - 1"x40"	TBD		N/A		2,186	N/A
TSV875-*1	875	105"	54"	3 - 1"x40"	TBD		TBD		1,596	2,200
TSV1000-*1	1,000	119"	54"	4 - 1"x40"	TBD		TBD		1,827	2,400
TSV1110-*1	1,110	129"	54"	4 - 1"x40"	TBD		TBD		1,889	2,575
TSV1217-*1	1,217	140"	54"	4 - 1"x40"	TBD		TBD		1,969	2,653
TSV1340-*1	1,340	153"	54"	5 - 1"x40"	TBD		N/A		2,182	N/A
TSV1442-*1	1,442	160"	54"	5 - 1"x40"	TBD		N/A		2,300	N/A
TSV1481-*1	1,481	166"	54"	5 - 1"x40"	TBD		N/A		2,402	N/A
TSV1500-*1	1,500	171"	54"	5 - 1"x40"	TBD		N/A		2,484	N/A
TSV1001-*1	1,000	102"	60"	3 - 1"x40"	TBD		TBD		2,007	2,600
TSV1245-*1	1,245	120"	60"	4 - 1"x40"	TBD		TBD		2,376	3,050
TSV1430-*1	1,430	134"	60"	4 - 1"x40"	TBD		TBD		2,475	3,175
TSV1530-*1	1,530	144"	60"	4 - 1"x40"	TBD		TBD		2,797	3,500
TSV1820-*1	1,820	174"	60"	6 - 1"x40"	TBD		N/A		3,210	N/A

Consult Factory for Larger & Custom Sizes and Other Tank Options Available

* Nomenclature:

TS	V	175	-	* J	1	
Thermal Solutions	Vertical	Actual Gallons		B = Bare J = Jacketed & Insulated T = Top Coat	1 = 10 Mils Glass 2 = 20 Mils Glass E = Epoxy	Blank = 125 Psig Design 150 = 150 Psig Design SPL = Special Build

Replacement Parts

Description	Part Number
125 PSI T&P Valve	109898-01
Diverter Tube	112491-01
Anode 1" x 28"	113140-04

Description	Part Number
Anode 1" x 34"	113140-03
Anode 1" x 40"	113140-02

- Notes:
- Shell & Heads: Carbon Steel - Max Temp: 180° F.
 - Exterior: Carbon Steel - Red Oxide Primer (Bare) / Baked Enamel 24 Gauge Steel with 2" R-12.5 Open Cell Foam (Jacket & Insulation).
 - Maximum Working Pressure: Carbon Steel - 125 PSIG.
 - Tank Pricing Includes Temperature & Pressure Relief Valve and Diverter Tube (Evenly Distributes Incoming Cold Water throughout the Vessel).
 - Top Coat is a Sprayed-On Rigid Insulation with Acrylic Top Coating that Exceeds ASHREE 90.1 Requirements with 2.25" of High-Density Polyurethane Foam with an "R" Value of R-16. SPF Meets Requirements for California Title 24. **The Top Coat can be used for Outdoor Use, too.**

STORAGE TANKS

STORAGE TANKS - LARGE VOLUME / VERTICAL

THERMAL SOLUTIONS STORAGE TANKS - LARGE VOLUME / VERTICAL, TSV MODELS

[5] Stainless Steel Tanks

* Model Sizes	Storage Capacity (Gallons)	Bare Dims (+ 4" to H & D for J&I)		Replacement Anodes (Qty & Size)	316 SS		Duplex SS		Shipping Weight
		OA Height (Aprx. Inches)	Diameter (Aprx. Inches)		Part Number	Part Number			
TSV175-*S*	175	67"	30"	2 - 1"x28"	TBD	TBD	TBD	CONSULT FACTORY	
TSV210-*S*	210	79"	30"	2 - 1"x28"	TBD	TBD	TBD		
TSV240-*S*	240	89"	30"	2 - 1"x28"	TBD	TBD	TBD		
TSV280-*S*	280	103"	30"	3 - 1"x28"	TBD	TBD	TBD		
TSV320-*S*	320	115"	30"	3 - 1"x28"	TBD	TBD	TBD		
TSV285-*S*	285	76"	36"	2 - 1"x34"	TBD	TBD	TBD		
TSV310-*S*	310	82"	36"	2 - 1"x34"	TBD	TBD	TBD		
TSV340-*S*	340	89"	36"	2 - 1"x34"	TBD	TBD	TBD		
TSV360-*S*	360	94"	36"	2 - 1"x34"	TBD	TBD	TBD		
TSV415-*S*	415	106"	36"	3 - 1"x28"	TBD	TBD	TBD		
TSV465-*S*	465	118"	36"	3 - 1"x28"	TBD	TBD	TBD		
TSV515-*S*	515	130"	36"	3 - 1"x34"	TBD	TBD	TBD		
TSV385-*S*	385	76"	42"	2 - 1"x40"	TBD	TBD	TBD		
TSV435-*S*	435	85"	42"	2 - 1"x40"	TBD	TBD	TBD		
TSV450-*S*	450	88"	42"	2 - 1"x40"	TBD	TBD	TBD		
TSV505-*S*	505	97"	42"	3 - 1"x28"	TBD	TBD	TBD		
TSV575-*S*	575	109"	42"	3 - 1"x34"	TBD	TBD	TBD		
TSV645-*S*	645	121"	42"	3 - 1"x34"	TBD	TBD	TBD		
TSV720-*S*	720	133"	42"	3 - 1"x40"	TBD	TBD	TBD		
TSV775-*S*	775	143"	42"	4 - 1"x34"	TBD	TBD	TBD		
TSV500-*S*	500	77"	48"	2 - 1"x40"	TBD	TBD	TBD		
TSV580-*S*	580	88"	48"	2 - 1"x40"	TBD	TBD	TBD		
TSV675-*S*	675	100"	48"	3 - 1"x34"	TBD	TBD	TBD		
TSV765-*S*	765	112"	48"	3 - 1"x40"	TBD	TBD	TBD		
TSV836-*S*	836	122"	48"	3 - 1"x40"	TBD	TBD	TBD		
TSV860-*S*	860	124"	48"	3 - 1"x40"	TBD	TBD	TBD		
TSV1040-*S*	1,040	145"	48"	4 - 1"x40"	TBD	TBD	TBD		

Consult Factory for Larger & Custom Sizes and Other Tank Options Available

* Nomenclature:

TS	V	175	-	* B	S	316
Thermal Solutions	Vertical	Actual Gallons		B = Bare J = Jacketed & Insulated T = Top Coat	S = Stainless Steel	316 = 316L Stainless DSS = Duplex Stainless SPL = Special Build

Replacement Parts

Description	Part Number
125 PSI T&P Valve	109898-01
Anode 1" x 28"	113140-04
Anode 1" x 34"	113140-03

Description	Part Number
Anode 1" x 40"	113140-02

- Notes:
- 1) Shell & Heads: Stainless Steel - Max Temp: 210° F.
 - 2) Exterior: Stainless Steel (Bare) / Baked Enamel 24 Gauge Steel with 2" R-12.5 Open Cell Foam (Jacket & Insulation).
 - 3) Maximum Working Pressure: Stainless Steel - 125 PSIG.
 - 4) Tank Pricing Includes Temperature & Pressure Relief Valve.
 - 5) Stainless Steel Tanks Warranty: Passivated 316L Carries a 10 Year Warranty and Passivated Duplex Stainless Steel Carries a 25 Year Warranty; (25 Year Warranty Prorated after 15 Years).
 - 6) Top Coat is a Sprayed-On Rigid Insulation with Acrylic Top Coating that Exceeds ASHREE 90.1 Requirements with 2.25" of High-Density Polyurethane Foam with an "R" Value of R-16. SPF Meets Requirements for California Title 24. **The Top Coat can be used for Outdoor Use, too.**

STORAGE TANKS

STORAGE TANKS - LARGE VOLUME / VERTICAL

THERMAL SOLUTIONS STORAGE TANKS - LARGE VOLUME / VERTICAL, TSV MODELS

Interior, Exterior and Tank Pressure Design Options

Model Sizes	Storage Capacity (Gallons)	Interior Lining Options		Exterior Options		150 PSI Tank Design	
		^[2] Epoxy	^[1] 20 Mils Glass	J&I	^[3] Top Coat	Carbon	SS
TSV175	175						
TSV210	210						
TSV240	240						
TSV280	280						
TSV320	320						
TSV285	285						
TSV310	310						
TSV340	340						
TSV360	360						
TSV415	415						
TSV465	465						
TSV515	515						
TSV385	385						
TSV435	435						
TSV450	450						
TSV505	505						
TSV575	575						
TSV645	645						
TSV720	720						
TSV775	775						
TSV500	500						
TSV580	580						
TSV675	675						
TSV765	765						
TSV836	836						
TSV860	860						
TSV1040	1,040						
TSV1225	1,225						
TSV875	875						
TSV1000	1,000						
TSV1110	1,110						
TSV1217	1,217						
TSV1340	1,340						
TSV1442	1,442						
TSV1481	1,481						
TSV1500	1,500						
TSV1001	1,000						
TSV1245	1,245						
TSV1430	1,430						
TSV1530	1,530						
TSV1820	1,820						

- Notes: 1) Standard 10 Mil Glass Lining has a 5 year warranty; Optional 20 Mil Glass Lining has a 10 year warranty.
 2) Epoxy Lining has a 1 year warranty
 3) Top Coat is a Sprayed-On Rigid Insulation with Acrylic Top Coating that Exceeds ASHREE 90.1 Requirements with 2.25" of High-Density Polyurethane Foam with an "R" Value of R-16. SPF Meets Requirements for California Title 24. **The Top Coat can be used for Outdoor Use, too.**

STORAGE TANKS

STORAGE TANKS - LARGE VOLUME / HORIZONTAL

THERMAL SOLUTIONS STORAGE TANKS - LARGE VOLUME / HORIZONTAL, TSH MODELS

Bare and Jacketed & Insulated Tanks

* Model Sizes	Storage Capacity (Gallons)	^Bare Dims (+ 4" to H & D for J&I)		Replacement Anodes (Qty & Size)	Bare Tank		J&I Tanks		Shipping Weight	
		OA Length (Inches)	Diameter (Inches)		Part Number		Part Number		Bare (Aprx. lbs)	J&I (Aprx. lbs)
TSH175-*1	175	63"	30"	2 - 1"x28"	TBD		TBD		365	570
TSH210-*1	210	75"	30"	2 - 1"x28"	TBD		TBD		412	613
TSH240-*1	240	85"	30"	2 - 1"x28"	TBD		TBD		545	755
TSH280-*1	280	99"	30"	3 - 1"x28"	TBD		TBD		508	728
TSH320-*1	320	111"	30"	3 - 1"x28"	TBD		TBD		555	774
TSH285-*1	285	72"	36"	2 - 1"x34"	TBD		TBD		576	776
TSH310-*1	310	78"	36"	2 - 1"x34"	TBD		TBD		614	827
TSH340-*1	340	85"	36"	2 - 1"x34"	TBD		TBD		659	876
TSH360-*1	360	90"	36"	2 - 1"x34"	TBD		TBD		690	935
TSH415-*1	415	102"	36"	3 - 1"x28"	TBD		TBD		768	1,016
TSH465-*1	465	114"	36"	3 - 1"x28"	TBD		TBD		844	1,157
TSH515-*1	515	126"	36"	3 - 1"x34"	TBD		TBD		920	1,260
TSH385-*1	385	72"	42"	2 - 1"x40"	TBD		TBD		747	935
TSH435-*1	435	81"	42"	2 - 1"x40"	TBD		TBD		810	1,110
TSH450-*1	450	84"	42"	2 - 1"x40"	TBD		TBD		832	1,049
TSH505-*1	505	93"	42"	3 - 1"x28"	TBD		TBD		874	1,181
TSH575-*1	575	105"	42"	3 - 1"x34"	TBD		TBD		900	1,263
TSH645-*1	645	117"	42"	3 - 1"x34"	TBD		TBD		984	1,352
TSH720-*1	720	129"	42"	3 - 1"x40"	TBD		TBD		1,068	1,460
TSH775-*1	775	139"	42"	4 - 1"x34"	TBD		TBD		1,138	1,547
TSH500-*1	500	73"	48"	2 - 1"x40"	TBD		TBD		1,090	1,449
TSH580-*1	580	84"	48"	2 - 1"x40"	TBD		TBD		1,213	1,593
TSH675-*1	675	96"	48"	3 - 1"x34"	TBD		TBD		1,350	1,750
TSH765-*1	765	108"	48"	3 - 1"x40"	TBD		TBD		1,485	1,803
TSH836-*1	836	116"	48"	3 - 1"x40"	TBD		TBD		1,619	2,069
TSH860-*1	860	120"	48"	3 - 1"x40"	TBD		TBD		1,664	2,141
TSH1040-*1	1,040	141"	48"	4 - 1"x40"	TBD		TBD		1,857	2,407
TSH1225-*1	1,225	168"	48"	5 - 1"x40"	TBD		N/A		2,160	N/A
TSH875-*1	875	99"	54"	3 - 1"x40"	TBD		TBD		1,696	2,275
TSH1000-*1	1,000	113"	54"	4 - 1"x40"	TBD		TBD		2,000	2,475
TSH1110-*1	1,110	123"	54"	4 - 1"x40"	TBD		TBD		2,124	2,650
TSH1217-*1	1,217	134"	54"	4 - 1"x40"	TBD		TBD		2,252	2,825
TSH1340-*1	1,340	147"	54"	5 - 1"x40"	TBD		N/A		2,306	N/A
TSH1442-*1	1,442	156"	54"	5 - 1"x40"	TBD		N/A		2,424	N/A
TSH1481-*1	1,481	160"	54"	5 - 1"x40"	TBD		N/A		2,526	N/A
TSH1500-*1	1,500	165"	54"	5 - 1"x40"	TBD		N/A		2,734	N/A
TSH1001-*1	1,000	96"	60"	3 - 1"x40"	TBD		TBD		2,548	2,675
TSH1245-*1	1,245	114"	60"	4 - 1"x40"	TBD		TBD		2,648	3,050
TSH1430-*1	1,430	128"	60"	4 - 1"x40"	TBD		TBD		2,736	3,175
TSH1530-*1	1,530	138"	60"	4 - 1"x40"	TBD		TBD		2,829	3,575
TSH1820-*1	1,820	168"	60"	6 - 1"x40"	TBD		N/A		3,560	N/A

Consult Factory for Larger & Custom Sizes and Other Tank Options Available

^ Add 9" to Diameter for Height

* Nomenclature:

TS	H	175	-	* J	1	
Thermal Solutions	Horizontal	Actual Gallons		B = Bare J = Jacketed & Insulated T = Top Coat	1 = 10 Mils Glass 2 = 20 Mils Glass E = Epoxy	Blank = 125 Psig Design 150 = 150 Psig Design SPL = Special Build

Replacement Parts

Description	Part Number
125 PSI T&P Valve	109898-01
Diverter Tube	112491-01
Anode 1" x 28"	113140-04

Description	Part Number
Anode 1" x 34"	113140-03
Anode 1" x 40"	113140-02

- Notes:
- 1) Shell & Heads: Carbon Steel - Max Temp: 180° F.
 - 2) Exterior: Carbon Steel - Red Oxide Primer (Bare) / Baked Enamel 24 Gauge Steel with 2" R-12.5 Open Cell Foam (Jacket & Insulation).
 - 3) Maximum Working Pressure: Carbon Steel - 125 PSIG.
 - 4) Tank Pricing Includes Temperature & Pressure Relief Valve and Diverter Tube (Evenly Distributes Incoming Cold Water throughout the Vessel).
 - 5) Top Coat is a Sprayed-On Rigid Insulation with Acrylic Top Coating that Exceeds ASHREE 90.1 Requirements with 2.25" of High-Density Polyurethane Foam with an "R" Value of R-16. SPF Meets Requirements for California Title 24. **The Top Coat can be used for Outdoor Use, too.**

STORAGE TANKS

STORAGE TANKS - LARGE VOLUME / HORIZONTAL

THERMAL SOLUTIONS STORAGE TANKS - LARGE VOLUME / HORIZONTAL, TSH MODELS

[5] Stainless Steel Tanks

* Model Sizes	Storage Capacity (Gallons)	^Bare Dims (+ 4" to H & D for J&I)		Replacement Anodes (Qty & Size)	316 SS		Duplex SS		Shipping Weight
		OA Length (Aprx. Inches)	Diameter (Aprx. Inches)		Part Number	Part Number			
TSH175-*S*	175	63"	30"	2 - 1"x28"	TBD	TBD	TBD	TBD	CONSULT FACTORY
TSH210-*S*	210	75"	30"	2 - 1"x28"	TBD	TBD	TBD	TBD	
TSH240-*S*	240	85"	30"	2 - 1"x28"	TBD	TBD	TBD	TBD	
TSH280-*S*	280	99"	30"	3 - 1"x28"	TBD	TBD	TBD	TBD	
TSH320-*S*	320	111"	30"	3 - 1"x28"	TBD	TBD	TBD	TBD	
TSH285-*S*	285	72"	36"	2 - 1"x34"	TBD	TBD	TBD	TBD	
TSH310-*S*	310	78"	36"	2 - 1"x34"	TBD	TBD	TBD	TBD	
TSH340-*S*	340	85"	36"	2 - 1"x34"	TBD	TBD	TBD	TBD	
TSH360-*S*	360	90"	36"	2 - 1"x34"	TBD	TBD	TBD	TBD	
TSH415-*S*	415	102"	36"	3 - 1"x28"	TBD	TBD	TBD	TBD	
TSH465-*S*	465	114"	36"	3 - 1"x28"	TBD	TBD	TBD	TBD	
TSH515-*S*	515	126"	36"	3 - 1"x34"	TBD	TBD	TBD	TBD	
TSH385-*S*	385	72"	42"	2 - 1"x40"	TBD	TBD	TBD	TBD	
TSH435-*S*	435	81"	42"	2 - 1"x40"	TBD	TBD	TBD	TBD	
TSH450-*S*	450	84"	42"	2 - 1"x40"	TBD	TBD	TBD	TBD	
TSH505-*S*	505	93"	42"	3 - 1"x28"	TBD	TBD	TBD	TBD	
TSH575-*S*	575	105"	42"	3 - 1"x34"	TBD	TBD	TBD	TBD	
TSH645-*S*	645	117"	42"	3 - 1"x34"	TBD	TBD	TBD	TBD	
TSH720-*S*	720	129"	42"	3 - 1"x40"	TBD	TBD	TBD	TBD	
TSH775-*S*	775	139"	42"	4 - 1"x34"	TBD	TBD	TBD	TBD	
TSH500-*S*	500	73"	48"	2 - 1"x40"	TBD	TBD	TBD	TBD	
TSH580-*S*	580	84"	48"	2 - 1"x40"	TBD	TBD	TBD	TBD	
TSH675-*S*	675	96"	48"	3 - 1"x34"	TBD	TBD	TBD	TBD	
TSH765-*S*	765	108"	48"	3 - 1"x40"	TBD	TBD	TBD	TBD	
TSH836-*S*	836	116"	48"	3 - 1"x40"	TBD	TBD	TBD	TBD	
TSH860-*S*	860	120"	48"	3 - 1"x40"	TBD	TBD	TBD	TBD	
TSH1040-*S*	1,040	141"	48"	4 - 1"x40"	TBD	TBD	TBD	TBD	

Consult Factory for Larger & Custom Sizes and Other Tank Options Available ^ Add 9" to Diameter for Height

* Nomenclature:

TS	H	175	-	* B	S	316
Thermal Solutions	Horizontal	Actual Gallons		B = Bare J = Jacketed & Insulated T = Top Coat	S = Stainless Steel	316 = 316L Stainless DSS = Duplex Stainless SPL = Special Build

Replacement Parts

Description	Part Number
125 PSI T&P Valve	109898-01
Anode 1" x 28"	113140-04
Anode 1" x 34"	113140-03

Description	Part Number
Anode 1" x 40"	113140-02

- Notes:
- 1) Shell & Heads: Stainless Steel - Max Temp: 210° F.
 - 2) Exterior: Stainless Steel (Bare) / Baked Enamel 24 Gauge Steel with 2" R-12.5 Open Cell Foam (Jacket & Insulation).
 - 3) Maximum Working Pressure: Stainless Steel - 125 PSIG.
 - 4) Tank Pricing Includes Temperature & Pressure Relief Valve.
 - 5) Stainless Steel Tanks Warranty: Passivated 316L Carries a 10 Year Warranty and Passivated Duplex Stainless Steel Carries a 25 Year Warranty; (25 Year Warranty Prorated after 15 Years).
 - 6) Top Coat is a Sprayed-On Rigid Insulation with Acrylic Top Coating that Exceeds ASHREE 90.1 Requirements with 2.25" of High-Density Polyurethane Foam with an "R" Value of R-16. SPF Meets Requirements for California Title 24. **The Top Coat can be used for Outdoor Use, too.**

STORAGE TANKS

STORAGE TANKS - LARGE VOLUME / HORIZONTAL

THERMAL SOLUTIONS STORAGE TANKS - LARGE VOLUME / HORIZONTAL, TSH MODELS

Interior, Exterior and Tank Pressure Design Options

Model Sizes	Storage Capacity (Gallons)	Interior Lining Options		Exterior Options		150 PSI Tank Design	
		Epoxy	20 Mils Glass	J&I	Top Coat	Carbon	SS
TSH175	175						
TSH210	210						
TSH240	240						
TSH280	280						
TSH320	320						
TSH285	285						
TSH310	310						
TSH340	340						
TSH360	360						
TSH415	415						
TSH465	465						
TSH515	515						
TSH385	385						
TSH435	435						
TSH450	450						
TSH505	505						
TSH575	575						
TSH645	645						
TSH720	720						
TSH775	775						
TSH500	500						
TSH580	580						
TSH675	675						
TSH765	765						
TSH836	836						
TSH860	860						
TSH1040	1,040						
TSH1225	1,225						
TSH875	875						
TSH1000	1,000						
TSH1110	1,110						
TSH1217	1,217						
TSH1340	1,340						
TSH1442	1,442						
TSH1481	1,481						
TSH1500	1,500						
TSH1001	1,000						
TSH1245	1,245						
TSH1430	1,430						
TSH1530	1,530						
TSH1820	1,820						

- Notes:
- 1) Standard 10 Mil Glass Lining has a 5 year warranty; Optional 20 Mil Glass Lining has a 10 year warranty.
 - 2) Epoxy Lining has a 1 year warranty
 - 3) Top Coat is a Sprayed-On Rigid Insulation with Acrylic Top Coating that Exceeds ASHREE 90.1 Requirements with 2.25" of High-Density Polyurethane Foam with an "R" Value of R-16. SPF Meets Requirements for California Title 24. **The Top Coat can be used for Outdoor Use, too.**

STORAGE TANKS

STORAGE TANKS - LARGE VOLUME / VERTICAL & HORIZONTAL

THEMAL SOLUTIONS STORAGE TANKS - LARGE VOLUME / VERTICAL & HORIZONTAL, TSV & H MODELS

Tank Illustrations (Samples)

TSV BARE MODELS

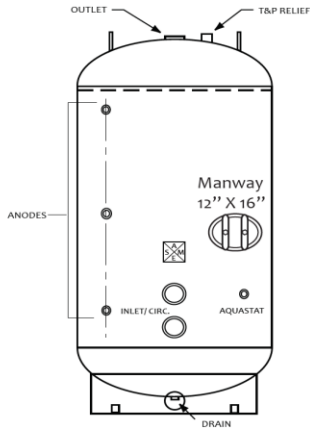

TSV JACKETED & INSULATED MODELS

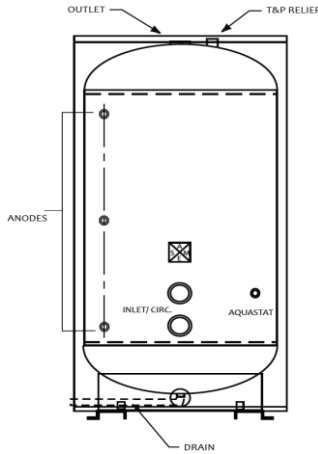

TSV TOP COATED MODELS

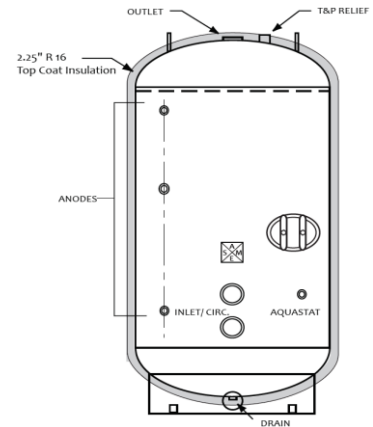

TSH BARE MODELS

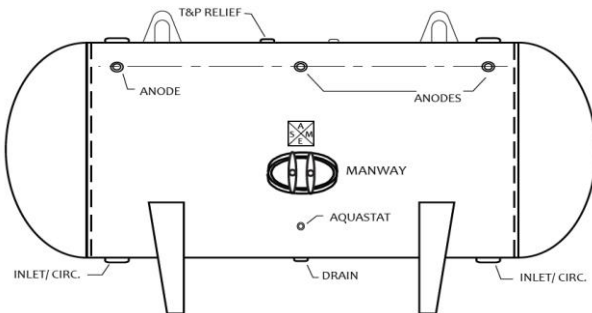

TSH JACKETED & INSULATED MODELS

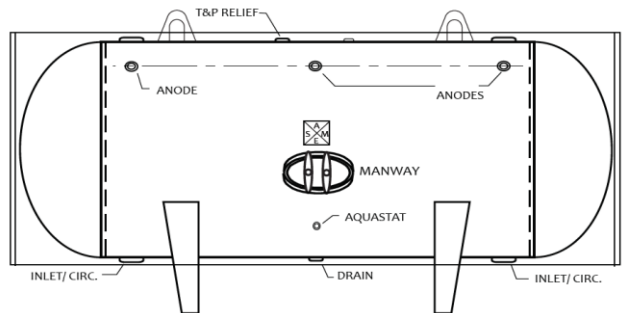

TSH TOP COATED MODELS

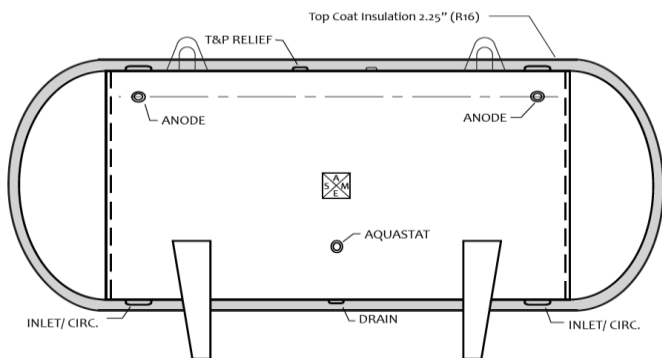

NOTE: The Above Illustrations for the Different Tank Orientations and Exterior Options are Sample Illustrations and Will Vary Depending on Model Size and Options.

THERMOSTATIC CONTROL VALVES

THERMOSTATIC CONTROL VALVES

FLUID POWER ENERGY (FPE) 3-WAY MIXING / DIVERTING VALVES

Model Sizes	Pipe Size (Inches)	Connection	"A" Height (Inches)	"B" Width/Depth (Inches)	Part Number	Shipping Weight (lbs)
A2010 - *	2	NPT	9 2/3	6 2/5	TBD	20.1
A2012 - *	2.0	NPT	8 1/3	7	TBD	19.7
A2510MZ-*	2.5	Flanged	10	10	TBD	47.3
A3010MZ-*	3	Flanged	10 3/5	10 1/2	TBD	55.2
A4010MZ-*	4	Flanged	13 1/5	16	TBD	113.6
A5010MZ-*	5	Flanged	19 1/2	19 1/3	TBD	155.0
A6010MZ-*	6	Flanged	24 4/5	19 1/3	TBD	220.5

* The return temperature
Class 125 PSI ANSI

A2010

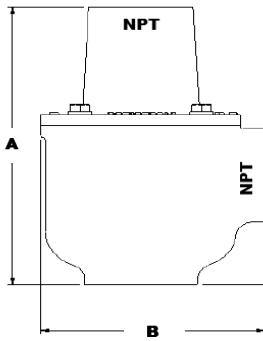

A2012

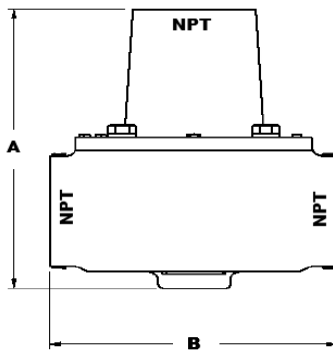

A2510MZ - A6010MZ

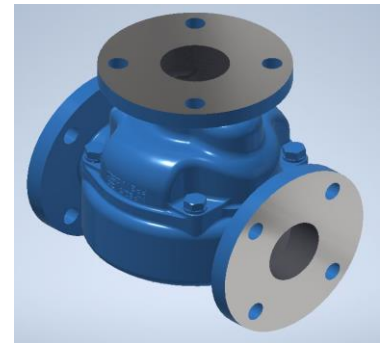
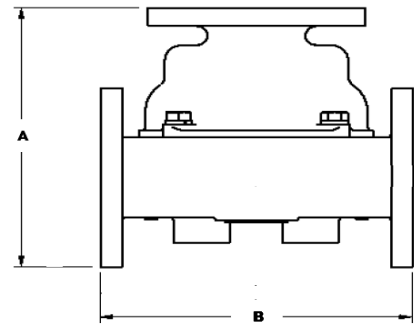

- Notes: 1) Exterior: Blue Paint Finish.
2) Maximum Working Pressure: 175 PSIG.

WATER HEATERS

INDIRECT WATER HEATERS

THEMAL SOLUTIONS HOT WATER GENERATORS, TSG MODELS

Hot Water Generators are equipped with 2 or 4 pass, single or double wall construction, U-bend tube bundle heat exchangers. We supply both "steam to water" and "water to water" systems. The system is operated by passing steam or hot water through the coil to heat the tank contents. Large heating capacity in small spaces makes a hot water generator particularly suitable for boiler rooms with low head room.

Nomenclature:

TS	G	V	175	-	*J	1	
Thermal Solutions	Generator	Vertical	Actual Gallons		B = Bare J = Jacketed & Insulated T = Top Coat	1 = 10 Mils Glass 2 = 20 Mils Glass E = Epoxy	Blank = 125 Psig Design 150 = 150 Psig Design SPL = Special Build

STORAGE TANK

+

TUBE BUNDLE HEAT EXCHANGER

+

RECIRCULATING PUMP PKG (OPTIONAL)

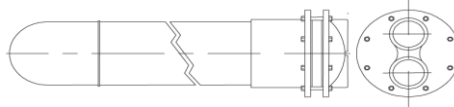
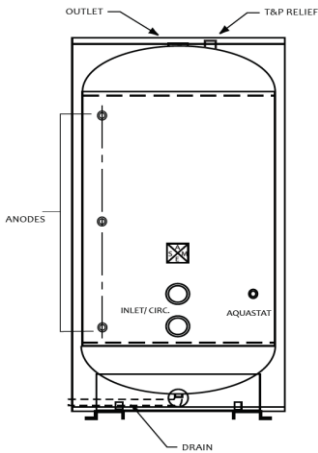

Hot Water Generators are equipped with 2 or 4 pass, single or double wall construction, U-bend tube bundle heat exchangers. We supply both steam to water and water to water systems. The system is operated by passing steam or hot water through the coil to heat the tank contents.

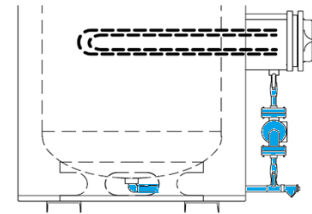

Circulated water is recommended, but not required. However, circulated water produces almost double the capacity of the Hot Water Generator.

CONTROL PACKAGES (OPTIONAL)

WATER TO WATER CONTROL PACKAGE

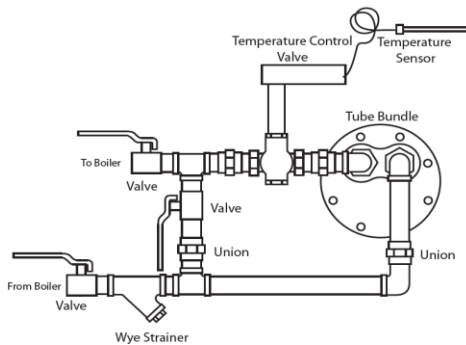

Package Includes:

- Temperature Control Valve
- High Limit Shutoff Valve
- Inlet Wye Strainer
- Isolation Valves
- Piping, Unions and Connections

STEAM TO WATER CONTROL PACKAGE

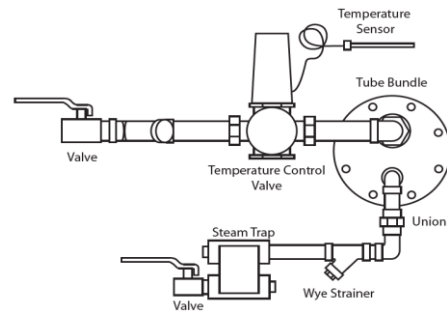

Package Includes:

- Temperature Control Valve
- High Limit Shutoff Valve
- Inlet Wye Strainer
- Steam Trap
- Isolation Valves
- Piping, Unions and Connections

Note: Consult Factory for Other Options not Published.

WATER HEATERS

INDIRECT WATER HEATERS

THERMAL SOLUTIONS HOT WATER GENERATORS (INDIRECT WATER HEATERS), TSG MODELS

Information Needed for Sizing & Quoting (Consult Factory for Pricing)

Heat Load: _____ Btu (Boiler output)

Tube Side (Boiler):

Fluid – Water/ * Steam

Inlet Temperature: _____ °F

Outlet Temperature: _____ °F

Flow Rate: _____ GPM

Tank Side (Storage):

Fluid – Water/ * Steam

Inlet Temperature: _____ °F

Outlet Temperature: _____ °F

Recovery Rate: _____ GPH

*Saturated Steam Temperatures for Reference

Gauge Pressure (Psig)	Temperature (°F)
0	212
1	215
2	219
3	222
4	224
5	227
6	230
7	232
8	233
9	237
10	239
12	244
14	248
16	252
18	256
20	259
22	262
24	265
26	268
28	271
30	274
32	277
34	279
36	282
38	284
40	286
42	289
44	291
46	293
48	295
50	298

Gauge Pressure (Psig)	Temperature (°F)
55	300
60	307
65	312
70	316
75	320
80	324
85	328
90	331
95	335
100	338
105	341
110	344
115	347
120	350
125	353
130	356
135	358
140	361
145	363
150	366
155	368
160	371
165	373
170	375
175	377
180	380
185	382
190	384
195	386
200	388
205	390

WATER HEATERS

INDIRECT WATER HEATERS

THERMAL SOLUTIONS POWER PLATE PACKAGES (INDIRECT WATER HEATERS), TSPP MODELS

Power Plate Water Heating Systems are a performance driven water heating package that comes with your choice of water storage tanks up to 2,500 gallons. The unique Power Plate heat exchanger design, single or double wall, provides high rates of heat transfer requiring less surface area than conventional shell & tube heat exchangers. Select from the choices of Storage Tanks offered in this price book or Consult Factory for custom-designed Storage Tank with Power Plate water heating.

Power Plate System Features Included:

- Brazed Plate Heat Exchangers (Single or Double Wall) Sized for Capacities up to 300 GPM Domestic Hot Water
- Controller that includes BACnet Communication for Building Automation
- Low Water Cutoff
- Grooved Connections for Easy Boiler Hook-up
- Factory Piping that Includes: Isolation Valves, Wye Strainer and Pump to the Storage Tank

*** Single Wall Heat Exchangers**

Model Sizes	Cold Water			Delta P (PSI)	Boiler Water 180°F			Single Wall HX Part Number	Shipping Weight (lbs)
	Flow (GPM)	Flow (GPH)	Temperature (In / Out)		Flow (GPM)	Return Temp.	Delta P (PSI)		
TSPPS-300	5	300	40-140°F	0.63	5	79°F	0.91	TBD	25.4
TSPPS-600	10	600	40-140°F	0.90	10	79°F	1.12	TBD	25.2
TSPPS-900	15	900	40-140°F	1.37	15	79°F	1.40	TBD	40.0
TSPPS-1200	20	1200	40-140°F	1.38	20	79°F	1.59	TBD	47.0
TSPPS-1500	25	1500	40-140°F	1.40	25	79°F	1.57	TBD	54.8
TSPPS-1800	30	1800	40-140°F	1.53	30	79°F	1.70	TBD	60.7
TSPPS-2400	40	2400	40-140°F	1.55	40	79°F	1.67	TBD	76.3
TSPPS-3000	50	3000	40-140°F	1.66	50	79°F	1.77	TBD	90.0
TSPPS-3600	60	3600	40-140°F	1.77	60	79°F	1.87	TBD	103.8
TSPPS-4200	70	4200	40-140°F	1.88	70	79°F	1.97	TBD	117.5

* Add Storage Tank pricing to the above TSPPS Power Plate pricing above.

*** Double Wall Heat Exchangers**

Model Sizes	Cold Water			Delta P (PSI)	Boiler Water 180°F			Single Wall HX Part Number	Shipping Weight (lbs)
	Flow (GPM)	Flow (GPH)	Temperature (In / Out)		Flow (GPM)	Return Temp.	Delta P (PSI)		
TSPPD-300	5	300	40-140°F	0.63	5	79°F	0.91	TBD	33.2
TSPPD-600	10	600	40-140°F	0.90	10	79°F	1.12	TBD	48.9
TSPPD-900	15	900	40-140°F	1.37	15	79°F	1.40	TBD	62.5
TSPPD-1200	20	1200	40-140°F	1.38	20	79°F	1.59	TBD	76.3
TSPPD-1500	25	1500	40-140°F	1.40	25	79°F	1.57	TBD	90.0
TSPPD-1800	30	1800	40-140°F	1.53	30	79°F	1.70	TBD	103.8
TSPPD-2400	40	2400	40-140°F	1.55	40	79°F	1.67	TBD	133.2
TSPPD-3000	50	3000	40-140°F	1.66	50	79°F	1.77	TBD	160.5
TSPPD-3600	60	3600	40-140°F	1.77	60	79°F	1.87	TBD	175.1
TSPPD-4200	70	4200	40-140°F	1.88	70	79°F	1.97	TBD	180.2

* Add Storage Tank pricing to the above TSPPS Power Plate pricing above.

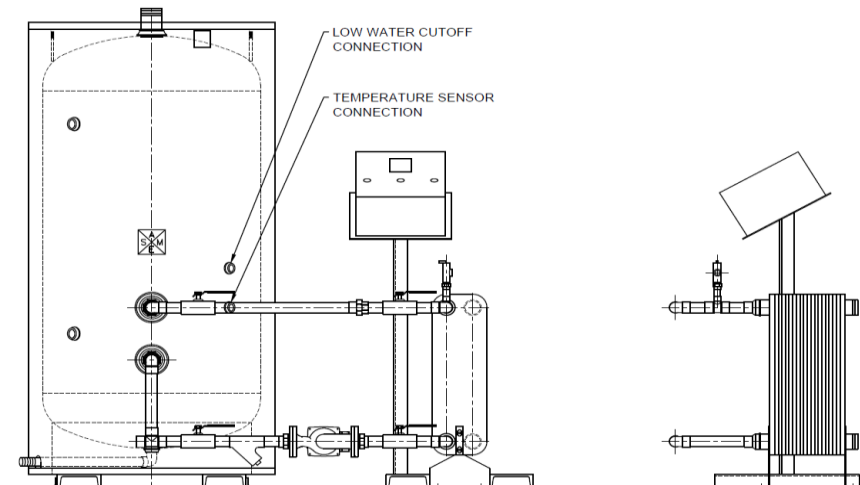

WATER HEATERS

INDIRECT WATER HEATERS

H2OMAX HEAT EXCHANGERS, H MODELS

Non-ASME Tanks

Model Sizes	Capacity (Gallons)	Overall Dimensions			Part Number	Non-ASME	Shipping Weight (lbs)
		Height	Width	Depth			
H26	26	42"	19.5"	19.5"	106807-01		210
H48	48	45"	24.5"	24.5"	106807-02		375
H72	72	49"	26.5"	26.5"	106807-03		575
H119	119	60"	30.5"	30.5"	106807-04		800

ASME Tanks

Model Sizes	Capacity (Gallons)	Overall Dimensions			Part Number	ASME	Shipping Weight (lbs)
		Height	Width	Depth			
H48A	48	45"	24.5"	24.5"	106807-05		425
H72A	72	49"	26.5"	26.5"	106807-06		625
H119A	119	60"	30.5"	30.5"	106807-07		850

Technical Information

Capacity (Gallons)	Heating Surface (Sq/Ft)	Maximum Design			Water Connections		
		Heat Exchanger (MAWP)	Boiler (MAWP)	Temp. (°F)	Domestic In / Out	Supply & Return System	
26	21.0	150 Psig	30 Psig	190	1.25"	1.00"	1.50"
48	26.2	150 Psig	60 Psig	190	1.50"	1.25"	1.50"
72	26.2	150 Psig	115 Psig	190	1.50"	1.50"	2.00"
119	47.1	150 Psig	115 Psig	190	2.00"	2.00"	2.00"

Standard Equipment: Steel Tank (AS36 Grade), Copper Coils, Jacket (22 gauge), Insulation (Fiberglass & Astrofoil - R15), Adjustable Feet for Leveling / Clearances, Temperature / Pressure Gauge, and Drain Valve.

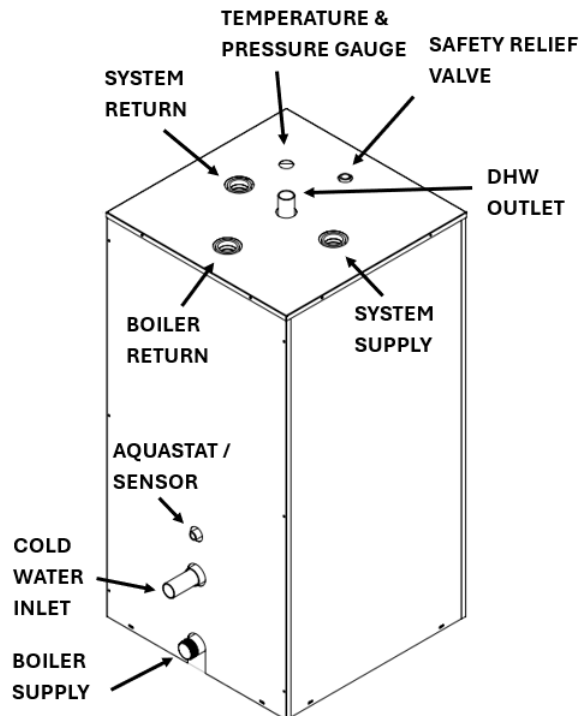

WATER HEATERS

DIRECT WATER HEATERS

THERMAL SOLUTIONS ELECTRIC WATER HEATERS, TSEV MODELS

Storage Tank Information

* Model Sizes	Storage Capacity (Gallons)	Maximum Killowatts (kw)	OA Height			Water Conn. (Inches)
			OA Height (Inches)	Diameter (Inches)	Depth (Inches)	
TSEV150 - J1*	150	90	67 1/2"	32	38 3/4"	1 1/2"
TSEV200 - J1*	200	162	80"	32	38 3/4"	1 1/2"
TSEV250 - J1*	250	162	92"	34	40 3/4"	1 1/2"
TSEV300 - J1*	300	162	80"	40	46 3/4"	2"
TSEV400 - J1*	400	216	80"	46	52 3/4"	2"
TSEV500 - J1*	500	216	92"	46	52 3/4"	2"
TSEV600 - J1*	600	216	92"	52	58 3/4"	2 1/2"
TSEV800 - J1*	800	270	104"	52	58 3/4"	2 1/2"
TSEV1000 - J1*	1,000	360	128"	52	58 3/4"	2 1/2"
TSEV1250 - J1*	1,250	360	133"	58	64 3/4"	3"
TSEV1500 - J1*	1,500	360	129"	64	70 3/4"	3"
TSEV2000 - J1*	2,000	360	140"	70	76 3/4"	3"
TSEV2500 - J1*	2,500	360	144"	76	82 3/4"	3"

Electric KW Information

Killowatts (kw)	Recovery 100°F Rise (GPH)	BTU/H Equiv.
12	49	40,944
15	62	51,180
18	74	61,416
30	123	102,360
36	148	122,832
45	185	153,540
54	221	184,248
60	246	204,720
72	295	245,664
90	369	307,080
108	443	368,496
120	492	409,440
135	554	460,620
144	590	491,328
162	664	552,744
180	738	614,160
216	886	736,992
234	959	798,408
252	1,033	859,824
270	1,107	921,240
288	1,181	982,656
306	1,256	1,044,072
324	1,328	1,105,488
342	1,402	1,166,904
360	1,476	1,228,320

Voltage Options

Voltage Options
J = 208v/1ph
K = 208v/3ph
A = 240v/1ph
B = 240v/3ph
W = 277v/1ph
Y = 380v/3ph
Q = 400v/3ph
Z = 415v/3ph
X = 480v/3ph
N = 600v/3ph

Miscellaneous Options

Options
A = BMS Contacts
B = Low Water Cut Off (LWCO)
C = Pilot Lights and Switches
D = Solid State Step Controls ^ (36kw and Higher)
E = Alarm Bell
F = Shunt Trip Disconnect
G = Low Water Pressure Switch
H = High Water Pressure Switch
J - Time Clock (7 day)
K - Time Clock (24 hour)
L = Safety Door Interlock
M = Pressure Gauge
N = Manway (Available on 250 Gallons and Above)

^ For standard tanks, reference our literature for quantity.

* Nomenclature:

TS	E	V	150	-	Exterior	Interior	Voltage	KW	Options
Thermal Solutions	Electric	Vertical	Actual Gallons		J = Jacketed & Insulated	1 = 10 Mills Glass Lining 2 = 20 Mills Glass Lining	See Above	See Above	See Above

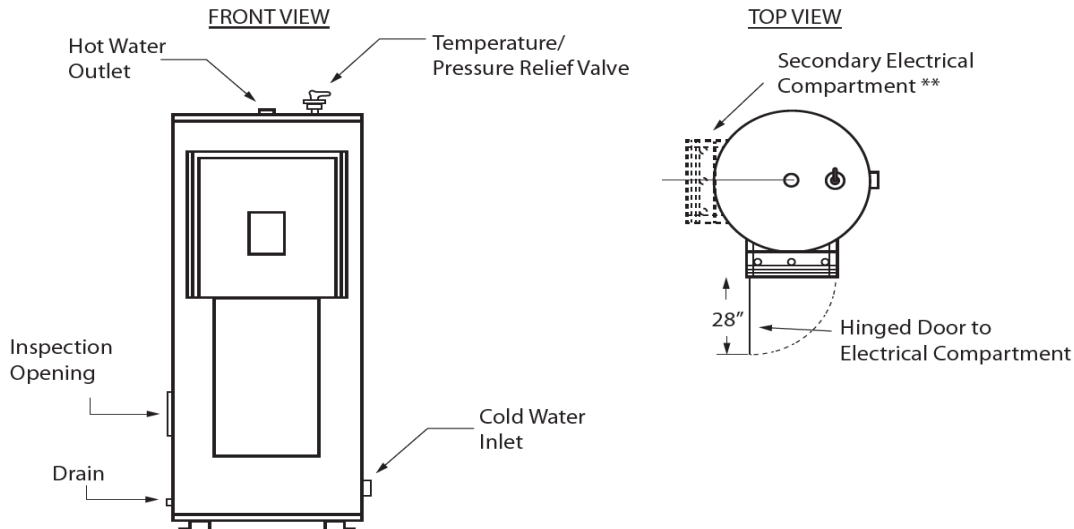

** Note: Vertical round models above 90kW at 208V / 240V or 380V and 162kW at 400V or 480V exceeds the capacity of a single control panel and may require multiple control panels. Consult the factory for specific details.

WATER HEATERS

DIRECT WATER HEATERS

THERMAL SOLUTIONS ELECTRIC WATER HEATERS, TSEV MODELS

Electrical 208V, 240V, 277V Pricing

* Model Sizes	Storage Capacity (Gallons)	Part Number	15 KW	18 KW	30 KW	36 KW
TSEV150 - J1*	150	TBD		TBD	TBD	TBD
TSEV200 - J1*	200	TBD		TBD	TBD	TBD
TSEV250 - J1*	250	TBD		TBD	TBD	TBD
TSEV300 - J1*	300	TBD		TBD	TBD	TBD
TSEV400 - J1*	400	TBD		TBD	TBD	TBD
TSEV500 - J1*	500	TBD		TBD	TBD	TBD
TSEV600 - J1*	600	TBD		TBD	TBD	TBD
TSEV800 - J1*	800	TBD		TBD	TBD	TBD
TSEV1000 - J1*	1,000	TBD		TBD	TBD	TBD
TSEV1250 - J1*	1,250	TBD		TBD	TBD	TBD
TSEV1500 - J1*	1,500	TBD		TBD	TBD	TBD
TSEV2000 - J1*	2,000	TBD		TBD	TBD	TBD
TSEV2500 - J1*	2,500	TBD		TBD	TBD	TBD

* Model Sizes	Storage Capacity (Gallons)	Part Number	45 KW	54 KW	60 KW	72 KW
TSEV150 - J1*	150	TBD		TBD	TBD	TBD
TSEV200 - J1*	200	TBD		TBD	TBD	TBD
TSEV250 - J1*	250	TBD		TBD	TBD	TBD
TSEV300 - J1*	300	TBD		TBD	TBD	TBD
TSEV400 - J1*	400	TBD		TBD	TBD	TBD
TSEV500 - J1*	500	TBD		TBD	TBD	TBD
TSEV600 - J1*	600	TBD		TBD	TBD	TBD
TSEV800 - J1*	800	TBD		TBD	TBD	TBD
TSEV1000 - J1*	1,000	TBD		TBD	TBD	TBD
TSEV1250 - J1*	1,250	TBD		TBD	TBD	TBD
TSEV1500 - J1*	1,500	TBD		TBD	TBD	TBD
TSEV2000 - J1*	2,000	TBD		TBD	TBD	TBD
TSEV2500 - J1*	2,500	TBD		TBD	TBD	TBD

* Model Sizes	Storage Capacity (Gallons)	Part Number	90 KW	108 KW	120 KW	135 KW
TSEV150 - J1*	150	TBD		N/A	N/A	N/A
TSEV200 - J1*	200	TBD		TBD	TBD	TBD
TSEV250 - J1*	250	TBD		TBD	TBD	TBD
TSEV300 - J1*	300	TBD		TBD	TBD	TBD
TSEV400 - J1*	400	TBD		TBD	TBD	TBD
TSEV500 - J1*	500	TBD		TBD	TBD	TBD
TSEV600 - J1*	600	TBD		TBD	TBD	TBD
TSEV800 - J1*	800	TBD		TBD	TBD	TBD
TSEV1000 - J1*	1,000	TBD		TBD	TBD	TBD
TSEV1250 - J1*	1,250	TBD		TBD	TBD	TBD
TSEV1500 - J1*	1,500	TBD		TBD	TBD	TBD
TSEV2000 - J1*	2,000	TBD		TBD	TBD	TBD
TSEV2500 - J1*	2,500	TBD		TBD	TBD	TBD

* Model Sizes	Storage Capacity (Gallons)	Part Number	144 KW	162 KW	180 KW	216 KW
TSEV200 - J1*	200	TBD		TBD	N/A	N/A
TSEV250 - J1*	250	TBD		TBD	N/A	N/A
TSEV300 - J1*	300	TBD		TBD	N/A	N/A
TSEV400 - J1*	400	TBD		TBD	TBD	TBD
TSEV500 - J1*	500	TBD		TBD	TBD	TBD
TSEV600 - J1*	600	TBD		TBD	TBD	TBD
TSEV800 - J1*	800	TBD		TBD	TBD	TBD
TSEV1000 - J1*	1,000	TBD		TBD	TBD	TBD
TSEV1250 - J1*	1,250	TBD		TBD	TBD	TBD
TSEV1500 - J1*	1,500	TBD		TBD	TBD	TBD
TSEV2000 - J1*	2,000	TBD		TBD	TBD	TBD
TSEV2500 - J1*	2,500	TBD		TBD	TBD	TBD

Note: Consult Factory for Other Options not Published.

WATER HEATERS

DIRECT WATER HEATERS

THERMAL SOLUTIONS ELECTRIC WATER HEATERS, TSEV MODELS

Electrical 208V, 240V, 277V Pricing

* Model Sizes	Storage Capacity (Gallons)	234 KW		252 KW		270 KW		288 KW	
		Part Number		Part Number		Part Number		Part Number	
TSEV800 - J1*	800	TBD		TBD		TBD		N/A	
TSEV1000 - J1*	1,000	TBD		TBD		TBD		TBD	
TSEV1250 - J1*	1,250	TBD		TBD		TBD		TBD	
TSEV1500 - J1*	1,500	TBD		TBD		TBD		TBD	
TSEV2000 - J1*	2,000	TBD		TBD		TBD		TBD	
TSEV2500 - J1*	2,500	TBD		TBD		TBD		TBD	

* Model Sizes	Storage Capacity (Gallons)	306 KW		324 KW		342 KW		360 KW	
		Part Number		Part Number		Part Number		Part Number	
TSEV1000 - J1*	1,000	TBD		TBD		TBD		TBD	
TSEV1250 - J1*	1,250	TBD		TBD		TBD		TBD	
TSEV1500 - J1*	1,500	TBD		TBD		TBD		TBD	
TSEV2000 - J1*	2,000	TBD		TBD		TBD		TBD	
TSEV2500 - J1*	2,500	TBD		TBD		TBD		TBD	

Electrical 380V, 400V, 415V, 480V, 600V Pricing

* Model Sizes	Storage Capacity (Gallons)	15 KW		18 KW		30 KW		36 KW	
		Part Number		Part Number		Part Number		Part Number	
TSEV150 - J1*	150	TBD		TBD		TBD		TBD	
TSEV200 - J1*	200	TBD		TBD		TBD		TBD	
TSEV250 - J1*	250	TBD		TBD		TBD		TBD	
TSEV300 - J1*	300	TBD		TBD		TBD		TBD	
TSEV400 - J1*	400	TBD		TBD		TBD		TBD	
TSEV500 - J1*	500	TBD		TBD		TBD		TBD	
TSEV600 - J1*	600	TBD		TBD		TBD		TBD	
TSEV800 - J1*	800	TBD		TBD		TBD		TBD	
TSEV1000 - J1*	1,000	TBD		TBD		TBD		TBD	
TSEV1250 - J1*	1,250	TBD		TBD		TBD		TBD	
TSEV1500 - J1*	1,500	TBD		TBD		TBD		TBD	
TSEV2000 - J1*	2,000	TBD		TBD		TBD		TBD	
TSEV2500 - J1*	2,500	TBD		TBD		TBD		TBD	

* Model Sizes	Storage Capacity (Gallons)	45 KW		54 KW		60 KW		72 KW	
		Part Number		Part Number		Part Number		Part Number	
TSEV150 - J1*	150	TBD		TBD		TBD		TBD	
TSEV200 - J1*	200	TBD		TBD		TBD		TBD	
TSEV250 - J1*	250	TBD		TBD		TBD		TBD	
TSEV300 - J1*	300	TBD		TBD		TBD		TBD	
TSEV400 - J1*	400	TBD		TBD		TBD		TBD	
TSEV500 - J1*	500	TBD		TBD		TBD		TBD	
TSEV600 - J1*	600	TBD		TBD		TBD		TBD	
TSEV800 - J1*	800	TBD		TBD		TBD		TBD	
TSEV1000 - J1*	1,000	TBD		TBD		TBD		TBD	
TSEV1250 - J1*	1,250	TBD		TBD		TBD		TBD	
TSEV1500 - J1*	1,500	TBD		TBD		TBD		TBD	
TSEV2000 - J1*	2,000	TBD		TBD		TBD		TBD	
TSEV2500 - J1*	2,500	TBD		TBD		TBD		TBD	

Note: Consult Factory for Other Options not Published.

WATER HEATERS

DIRECT WATER HEATERS

THERMAL SOLUTIONS ELECTRIC WATER HEATERS, TSEV MODELS

Electrical 380V, 400V, 415V, 480V, 600V Pricing

* Model Sizes	Storage Capacity (Gallons)	90 KW		108 KW		120 KW		135 KW	
		Part Number		Part Number		Part Number		Part Number	
TSEV150 - J1*	150	TBD		N/A		N/A		N/A	
TSEV200 - J1*	200	TBD		TBD		TBD		TBD	
TSEV250 - J1*	250	TBD		TBD		TBD		TBD	
TSEV300 - J1*	300	TBD		TBD		TBD		TBD	
TSEV400 - J1*	400	TBD		TBD		TBD		TBD	
TSEV500 - J1*	500	TBD		TBD		TBD		TBD	
TSEV600 - J1*	600	TBD		TBD		TBD		TBD	
TSEV800 - J1*	800	TBD		TBD		TBD		TBD	
TSEV1000 - J1*	1,000	TBD		TBD		TBD		TBD	
TSEV1250 - J1*	1,250	TBD		TBD		TBD		TBD	
TSEV1500 - J1*	1,500	TBD		TBD		TBD		TBD	
TSEV2000 - J1*	2,000	TBD		TBD		TBD		TBD	
TSEV2500 - J1*	2,500	TBD		TBD		TBD		TBD	

* Model Sizes	Storage Capacity (Gallons)	144 KW		162 KW		180 KW		216 KW	
		Part Number		Part Number		Part Number		Part Number	
TSEV200 - J1*	200	TBD		TBD		N/A		N/A	
TSEV250 - J1*	250	TBD		TBD		N/A		N/A	
TSEV300 - J1*	300	TBD		TBD		N/A		N/A	
TSEV400 - J1*	400	TBD		TBD		TBD		TBD	
TSEV500 - J1*	500	TBD		TBD		TBD		TBD	
TSEV600 - J1*	600	TBD		TBD		TBD		TBD	
TSEV800 - J1*	800	TBD		TBD		TBD		TBD	
TSEV1000 - J1*	1,000	TBD		TBD		TBD		TBD	
TSEV1250 - J1*	1,250	TBD		TBD		TBD		TBD	
TSEV1500 - J1*	1,500	TBD		TBD		TBD		TBD	
TSEV2000 - J1*	2,000	TBD		TBD		TBD		TBD	
TSEV2500 - J1*	2,500	TBD		TBD		TBD		TBD	

* Model Sizes	Storage Capacity (Gallons)	234 KW		252 KW		270 KW		288 KW	
		Part Number		Part Number		Part Number		Part Number	
TSEV800 - J1*	800	TBD		TBD		TBD		N/A	
TSEV1000 - J1*	1,000	TBD		TBD		TBD		TBD	
TSEV1250 - J1*	1,250	TBD		TBD		TBD		TBD	
TSEV1500 - J1*	1,500	TBD		TBD		TBD		TBD	
TSEV2000 - J1*	2,000	TBD		TBD		TBD		TBD	
TSEV2500 - J1*	2,500	TBD		TBD		TBD		TBD	

* Model Sizes	Storage Capacity (Gallons)	306 KW		324 KW		342 KW		360 KW	
		Part Number		Part Number		Part Number		Part Number	
TSEV1000 - J1*	1,000	TBD		TBD		TBD		TBD	
TSEV1250 - J1*	1,250	TBD		TBD		TBD		TBD	
TSEV1500 - J1*	1,500	TBD		TBD		TBD		TBD	
TSEV2000 - J1*	2,000	TBD		TBD		TBD		TBD	
TSEV2500 - J1*	2,500	TBD		TBD		TBD		TBD	

Note: Consult Factory for Other Options not Published.

WATER HEATERS

DIRECT WATER HEATERS

THERMAL SOLUTIONS ELECTRIC WATER HEATERS, TSEV MODELS

20 Mills Glass Lining Option Adders

* Model Sizes	Storage Capacity (Gallons)	20 Mills Glass Lining Part Number
TSEV150 - J2*	150	TBD
TSEV200 - J2*	200	TBD
TSEV250 - J2*	250	TBD
TSEV300 - J2*	300	TBD
TSEV400 - J2*	400	TBD
TSEV500 - J2*	500	TBD
TSEV600 - J2*	600	TBD
TSEV800 - J2*	800	TBD
TSEV1000 - J2*	1,000	TBD
TSEV1250 - J2*	1,250	TBD
TSEV1500 - J2*	1,500	TBD
TSEV2000 - J2*	2,000	TBD
TSEV2500 - J2*	2,500	TBD

Miscellaneous Option Adders

Miscellaneous Option Adders	Part Number
A - BMS Contacts - Building Management System Interface.	TBD
B - Low Water Cut-Off - Prevents energizing of the heater when not filled with water or upon low water condition.	TBD
C - Pilot Lights and Manual Limiting Switches - Pilot indicating lights and limiting switches permits manual limitation of heating input by switching off current to each contactor.	TBD
D - Electric Step Controller (36 kw & higher) - Electronic sequencing of thermostats.	
1-4 steps	TBD
5-8 steps	TBD
9-12 steps	TBD
E - Alarm Bell - Audible warning of various failures.	TBD
F - * Shunt Trip Disconnect - Provides maximum protection by interrupting all power to the system in the event of a control sensed malfunction or over current (* Field-Mounted).	TBD
G - Low Pressure Switch - Turns off control circuit when water pressure drops below a set minimum.	TBD
H - High Pressure Switch - Turns off control circuit when water pressure exceeds a set maximum.	TBD
J - 7 Day Clock - To control off/on cycles of the heater as programmed by the owner or electric utility requirement.	TBD
K - 24 Hour Clock - to control on/off cycles in 24 hr. cycles.	TBD
L - Safety Door Interlock - Prevents opening of access door while heater is energized.	TBD
M - Temperature and Pressure Gauges - Jacket mounted for convenient viewing.	TBD
N - Manway - Provides means to easily remove sediment from heater, only available on 250 gallon and larger.	TBD