

## Large Volume Hot Water Storage Tanks

### Tank Model TSV415-J\*

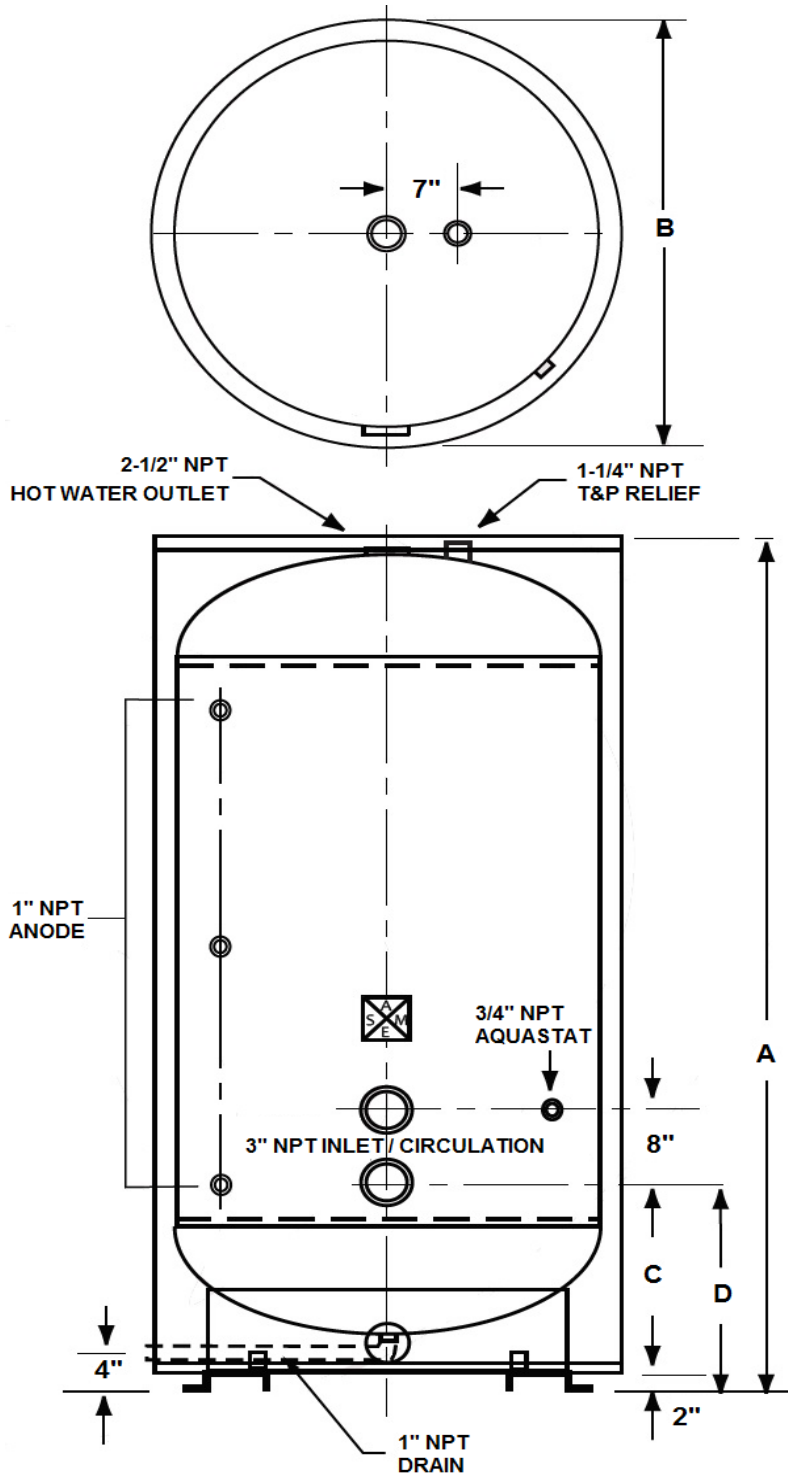

TECHNICAL DATA	
<b>CAPACITY:</b>	415 Gallon
<b>CONFIGURATION:</b>	Vertical
<b>INTERIOR (LINING):</b>	*Glass or Epoxy
<b>EXTERIOR:</b>	Steel Jacket with 2" Insulation
<b>DESIGN PRESSURE:</b>	125 psi
<b>DESIGN BUILD:</b>	ASME Section IV HLW Carbon Steel
<b>WEIGHT:</b>	985 lbs

\* 1 = 10 Mils Glass Thickness; 2 = 20 Mils Glass Thickness; E = Epoxy

DIMENSIONS		
ID	DESCRIPITON	DIMENSION
A	Height, Overall	110"
B	Diameter	40"
C	Circ., Bottom Conn. To Tank Bottom	19"
D	Circulation, Bottom Conn. To Floor	21"

SUBMITTAL	
<b>JOB NAME:</b>	-----
<b>LOCATION:</b>	-----
<b>ENGINEER:</b>	-----
<b>WHOLESALE:</b>	-----
<b>CONTRACTOR:</b>	-----
<b>DATE:</b>	-----

**Notes:**

- 1) Tank information is subject to change without notice.
- 2) Tank options are available; Consult Factory.