

## Large Volume Hot Water Storage Tanks

### Tank Model TSH580-B\*

TECHNICAL DATA	
<b>CAPACITY:</b>	580 Gallon
<b>CONFIGURATION:</b>	Horizontal
<b>INTERIOR (LINING):</b>	*Glass or Epoxy
<b>EXTERIOR:</b>	Red Oxide Primer
<b>DESIGN PRESSURE</b>	125 psi
<b>DESIGN BUILD:</b>	ASME Section IV HLW Carbon Steel
<b>WEIGHT:</b>	1215 lbs

\* 1 = 10 Mils Glass Thickness; 2 = 20 Mils Glass Thickness; E = Epoxy

DIMENSIONS		
ID	DESCRIPTION	DIMENSION
A	Height, Overall	57"
B	Diameter	48"
C	Length, Overall	84"
D	Circulation, Conn. To Tank Centerline	24"
E	Saddle Support, Distance Between	24"
F	Saddle Support, Width	42-1/8"

SUBMITTAL	
JOB NAME:	
LOCATION:	
ENGINEER:	
WHOLESALER:	
CONTRACTOR:	
DATE:	

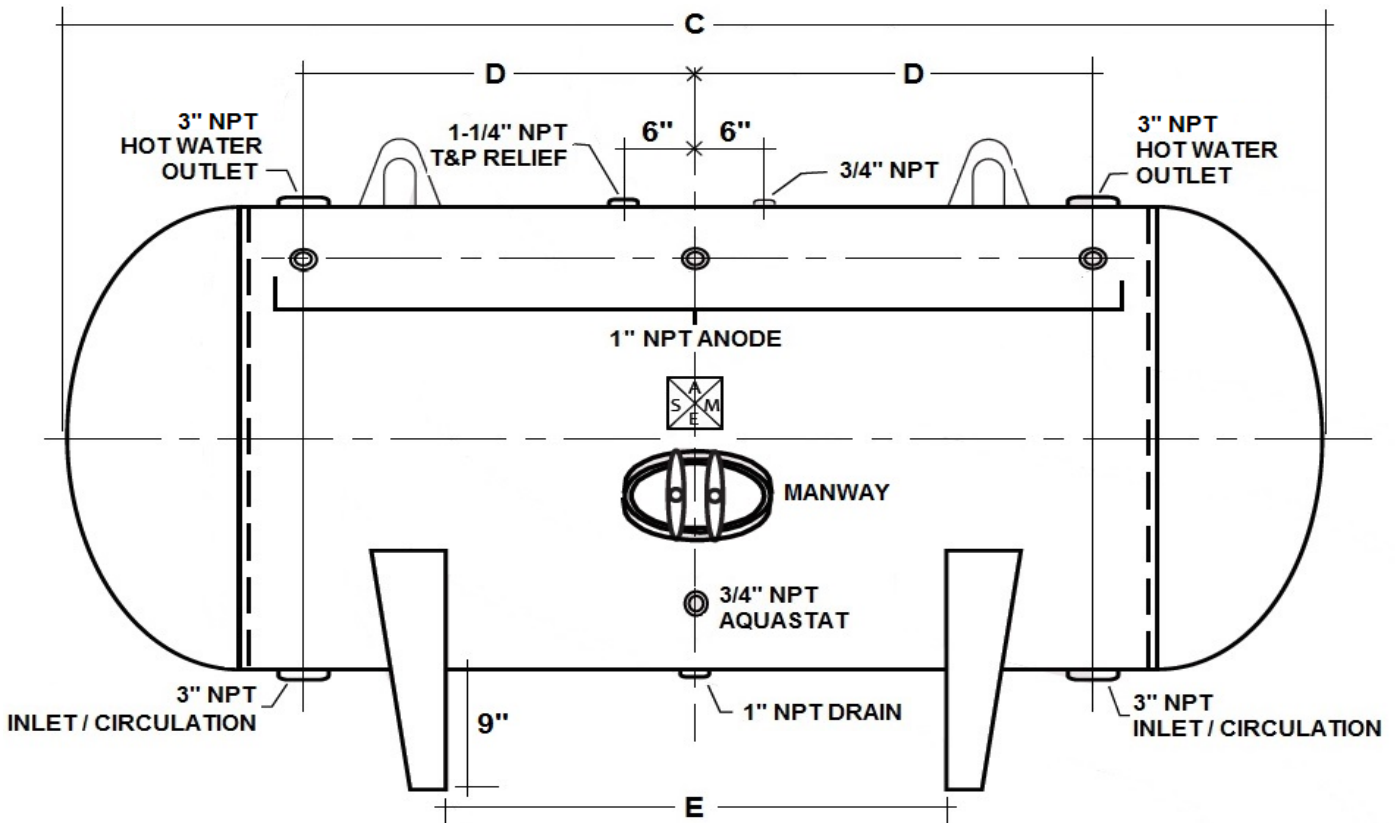
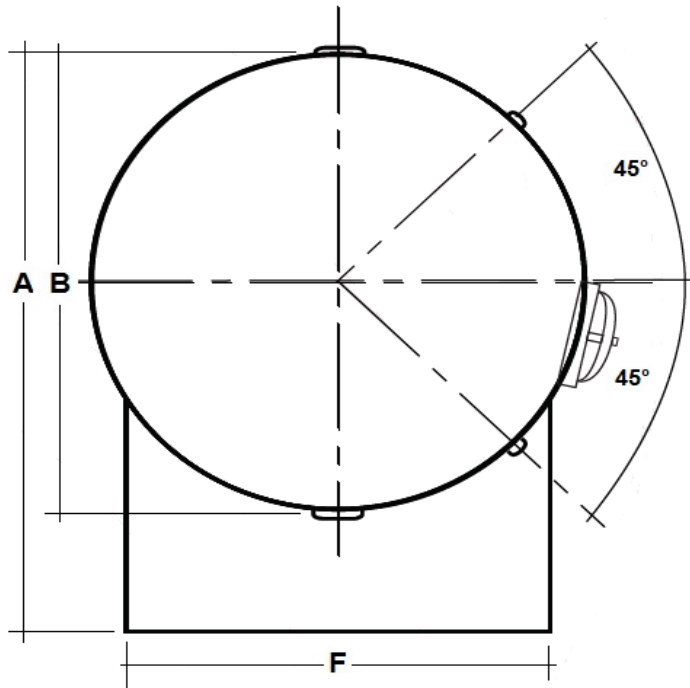

**Notes:**

- 1) Tank information is subject to change without notice.
- 2) Tank options are available; Consult Factory.