

Large Volume Hot Water Storage Tanks

Tank Model TSV210-B*

TECHNICAL DATA	
CAPACITY:	210 Gallon
CONFIGURATION:	Vertical
INTERIOR (LINING):	*Glass or Epoxy
EXTERIOR:	Red Oxide Primer
DESIGN PRESSURE:	125 psi
DESIGN BUILD:	ASME Section IV HLW Carbon Steel
WEIGHT:	390 lbs

* 1 = 10 Mils Glass Thickness; 2 = 20 Mils Glass Thickness; E = Epoxy

DIMENSIONS		
ID	DESCRIPITON	DIMENSION
A	Height, Overall	79"
B	Diameter	30"
C	Circ., Bottom Conn. To Tank Bottom	13-1/2"
D	Circulation, Bottom Conn. To Floor	17-1/2"

SUBMITTAL	
JOB NAME:	_____
LOCATION:	_____
ENGINEER:	_____
WHOLESALE:	_____
CONTRACTOR:	_____
DATE:	_____

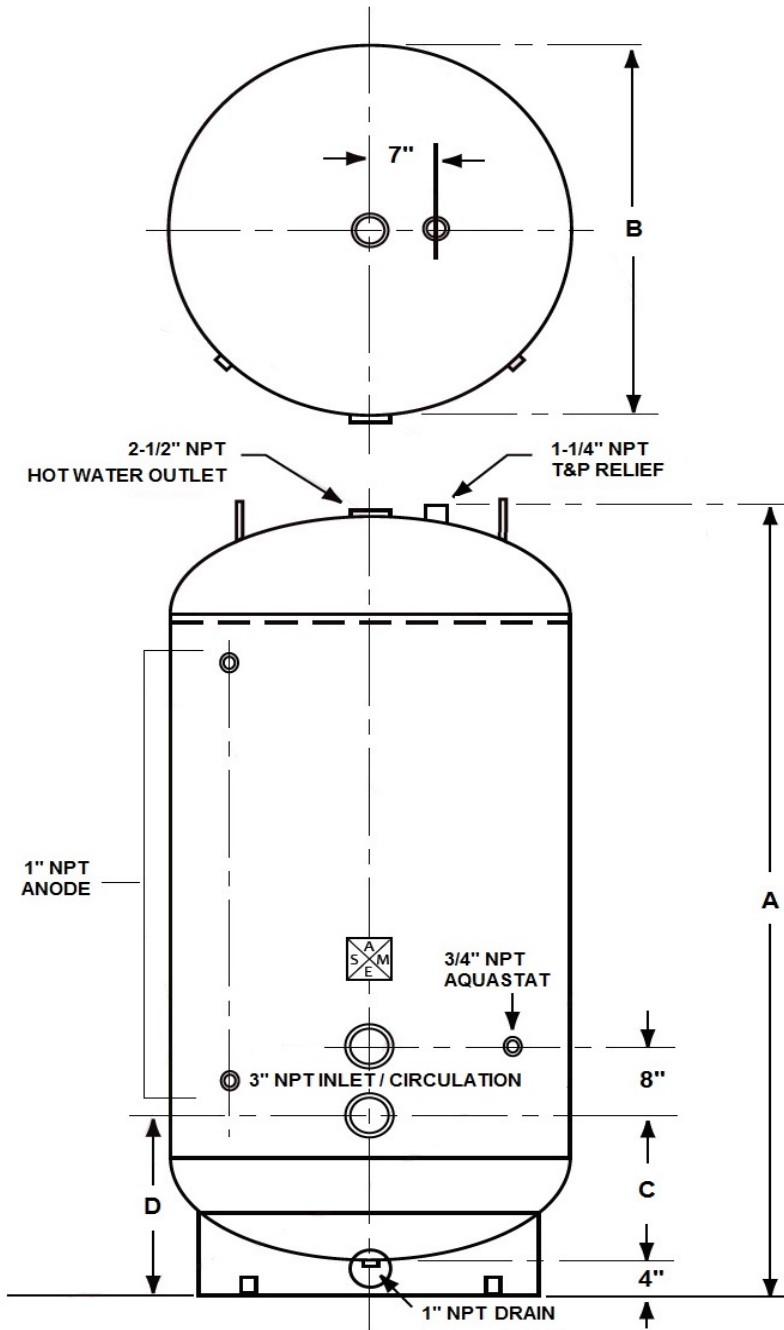

- Notes:
- 1) Tank information is subject to change without notice.
 - 2) Tank options are available; Consult Factory.