

Large Volume Hot Water Storage Tanks

Tank Model TSH435-J*

TECHNICAL DATA	
CAPACITY:	435 Gallon
CONFIGURATION:	Horizontal
INTERIOR (LINING):	*Glass or Epoxy
EXTERIOR:	Steel Jacket with 2" Insulation
DESIGN PRESSURE	125 psi
DESIGN BUILD:	ASME Section IV HLW Carbon Steel
WEIGHT:	1050 lbs

* 1 = 10 Mils Glass Thickness; 2 = 20 Mils Glass Thickness; E = Epoxy

DIMENSIONS		
ID	DESCRIPTION	DIMENSION
A	Height, Overall	53"
B	Diameter	46"
C	Length, Overall	85"
D	Circulation, Conn. To Tank Centerline	24"
E	Saddle Support, Distance Between	24"
F	Saddle Support, Width	36-3/4"

SUBMITTAL	
JOB NAME:	
LOCATION:	
ENGINEER:	
WHOLESALER:	
CONTRACTOR:	
DATE:	

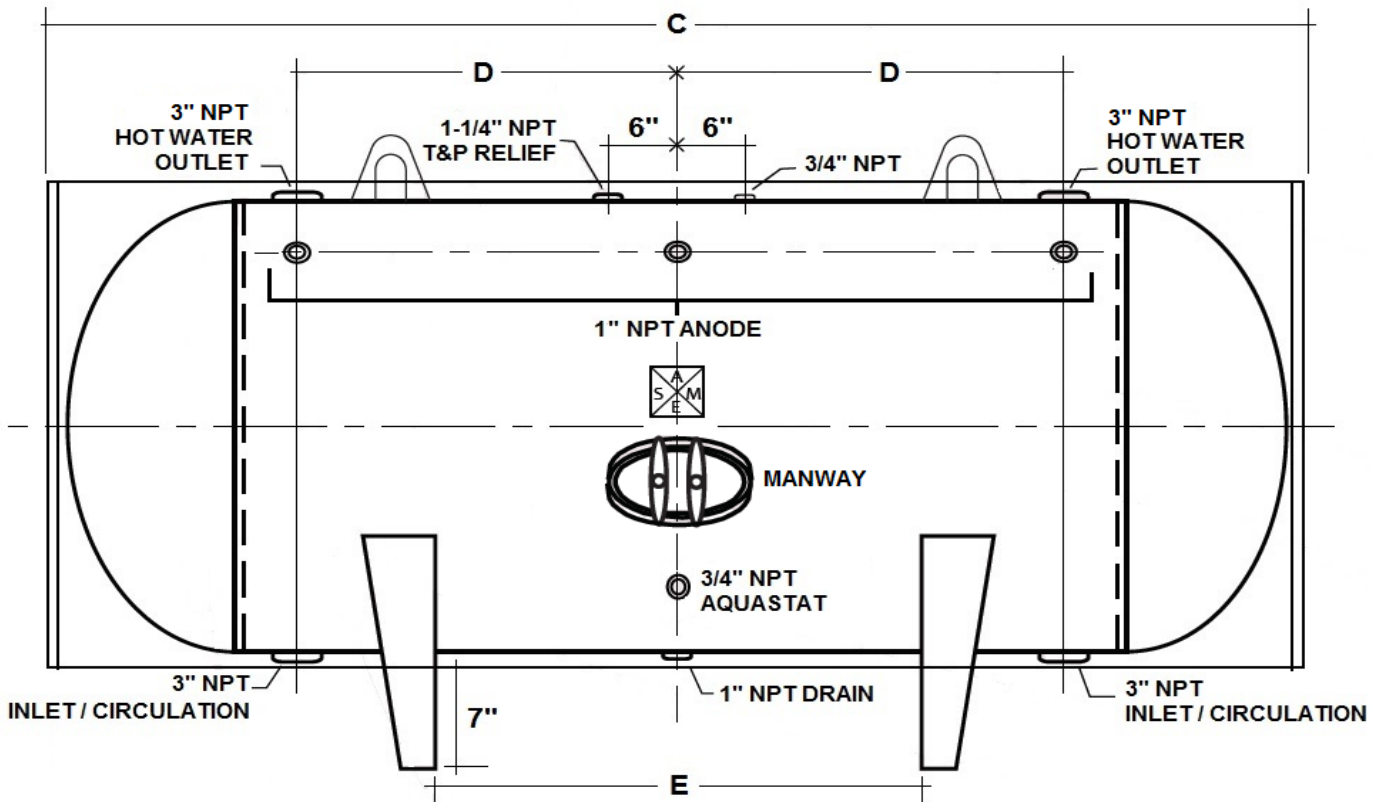
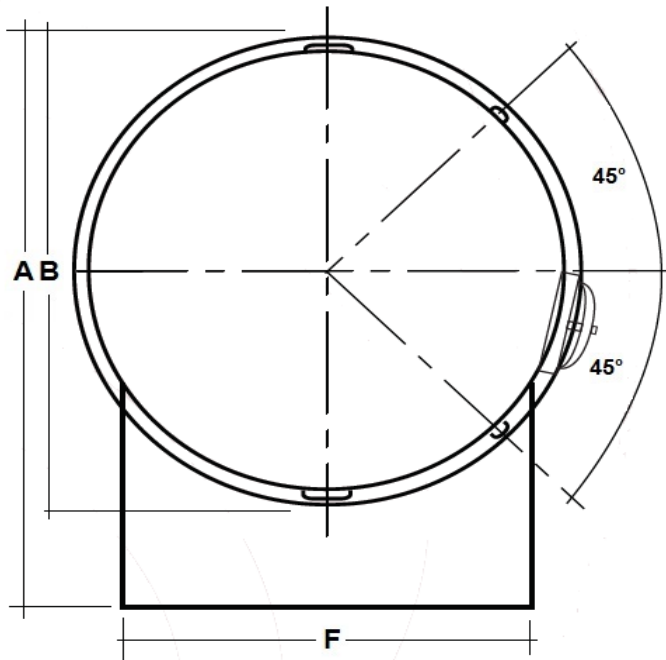

Notes:

- 1) Tank information is subject to change without notice.
- 2) Tank options are available; Consult Factory.